

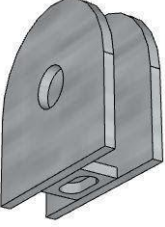

Table of Contents

Table of Contents	1
Hardware	2
Before You Begin: Types of Installation	2
Before You Begin: Configuration of Door Panels	5
Step1: Measurements	9
For installation above a ceramic or stone shower base:	10
For installation above a bathtub, or above a plastic or acrylic shower pan:	11
Step 2: Sliding Door Rollers and Handle	12
Step 3: Install the Roller Support Bar	18
Step 4: Install the Fixed Panel Support (Ceramic / Stone Shower Base)	27
Step 4: Install the Fixed Panel Support (Plastic / Acrylic Shower Pan or Tub)	29
Step 5: Install the Fixed Panel	34
Step 6: Install the Sliding Door	42
Step 7: Seals and Threshold	48

Hardware

The following parts are included in your installation kit. The parts you need will depend on your type of installation: above a ceramic/stone shower base, above a plastic / acrylic shower pan, or above a bathtub.

Please ensure that you have all the required hardware before you get started:

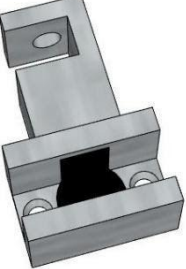
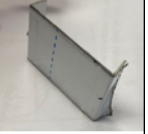
Part	Name	Qty	Part	Name	Qty
	Anti-Lift Fitting	2		Glass Mounting Clamp	2
	Roller	2		Recessed Pull	1
	Floor Guide	1		Cover Plate for Stop	2

METRO SHOW DOOR:
INSTALLATION INSTRUCTIONS

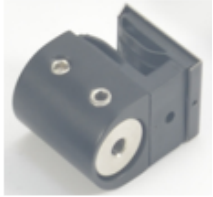
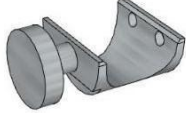

	Wall Mount End Cap with Stop	2		Fixed Panel Clamp	2
---	------------------------------------	---	--	----------------------	---

	<p>Various Shims</p>		
	<p>Roller Support Bar</p>	<p>(Cut to fit)</p>	<p>1</p>
	<p>U Channel (For installation above a bathtub or acrylic / plastic shower pan)</p>	<p>(Cut to fit)</p>	<p>1</p>
	<p>Half-Moon Threshold</p>		
	<p>Bulb Seal</p>		<p>1</p>

METRO SHOW DOOR:
INSTALLATION INSTRUCTIONS



	Bottom Sweep		1
---	--------------	--	---

METRO SHOW DOOR:
INSTALLATION INSTRUCTIONS



	Vertical Soft Edge PVC		1
---	---------------------------	--	---

Before You Begin: Types of Installation

The Metro shower door system can be installed in nearly every type of shower enclosure. There are three main types of installation:

- Above a ceramic or stone (drillable) shower base:



METRO SHOW DOOR:
INSTALLATION INSTRUCTIONS



- Above an acrylic or plastic (non-drillable) shower pan:

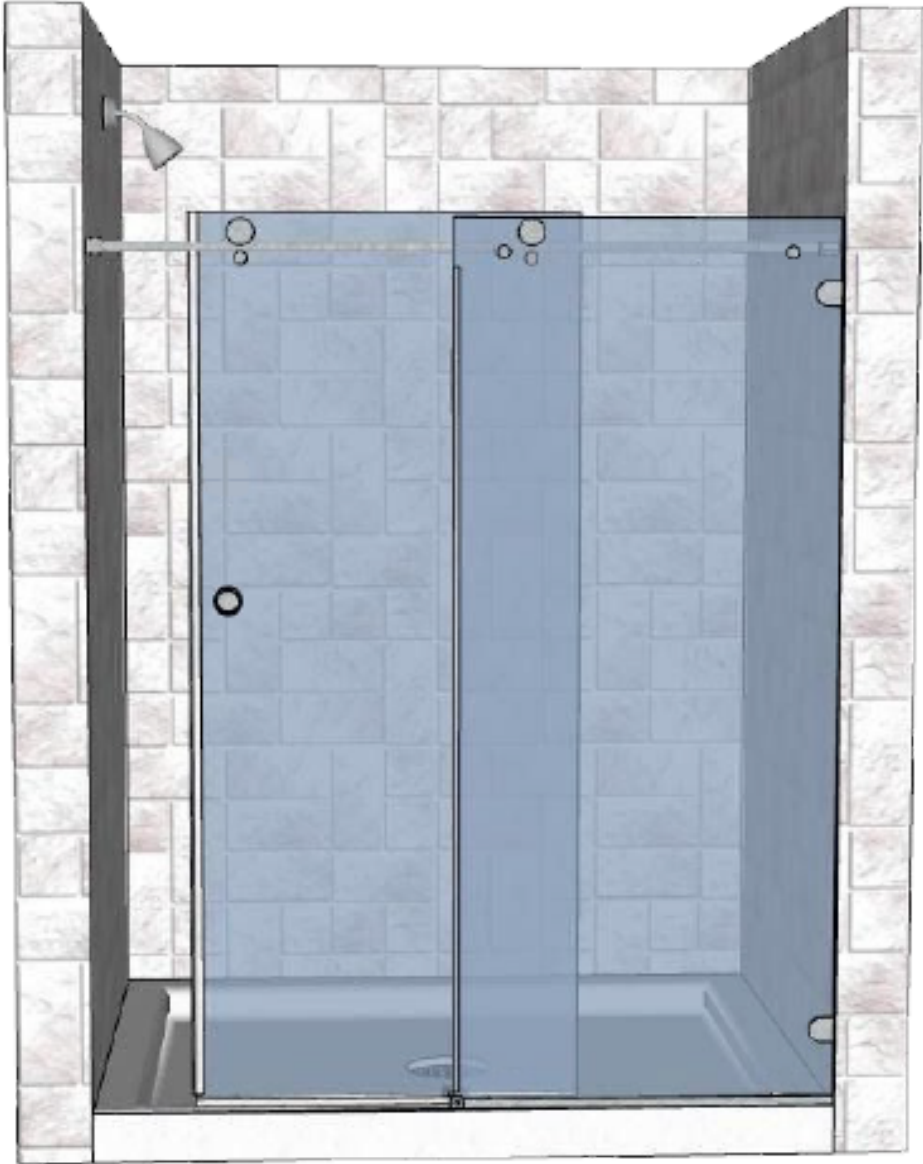

- Above a bathtub:

For each of these installation scenarios, the sliding door mechanism works the same way. However, what will vary is the way the fixed panels are attached to the walls and base. So please verify your installation method and use the instruction steps specified for your type of shower or bath.

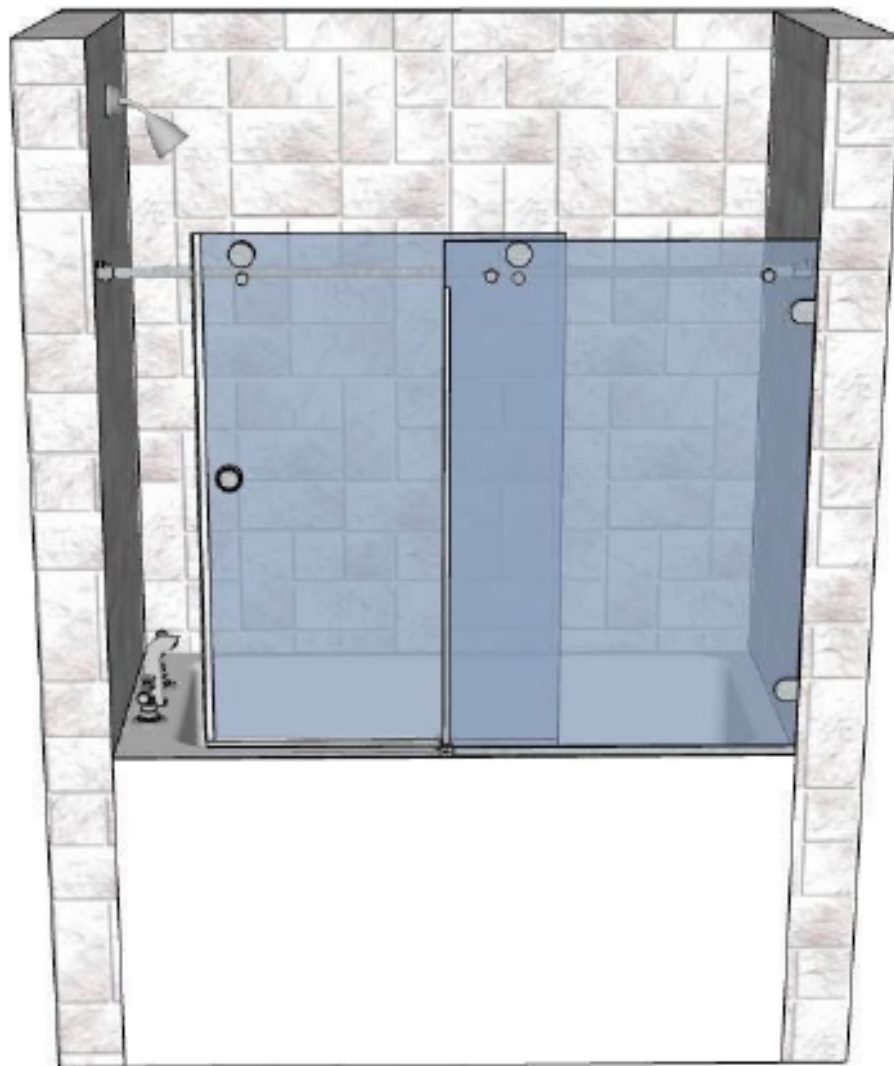

Before You Begin: Configuration of Door Panels

The Metro shower door system is flexible in terms of placement and location. Before starting installation, you'll need to decide:

- Whether the fixed panel or sliding door will be on the same side as the shower head
- Whether the sliding door will be in front of, or behind, the fixed panel

But before you decide, keep this in mind: While it's possible to install using any placement configuration, we strongly recommend the following configuration, to best prevent leakage:

- Place the sliding door on the same side as the shower head



- Place the sliding door behind the fixed panel (sliding door inside, fixed panel outside)



The following installation instructions will reflect the above-recommended configuration.

Step1: Measurements

Before beginning the installation, several accurate measurements of the shower/bath enclosure are required. These measurements will determine the measurements of other parts.

- WIDTH is the clear space between enclosure walls.
- HEIGHT is the door height, measured from the top of the shower base, shower pan, or tub.

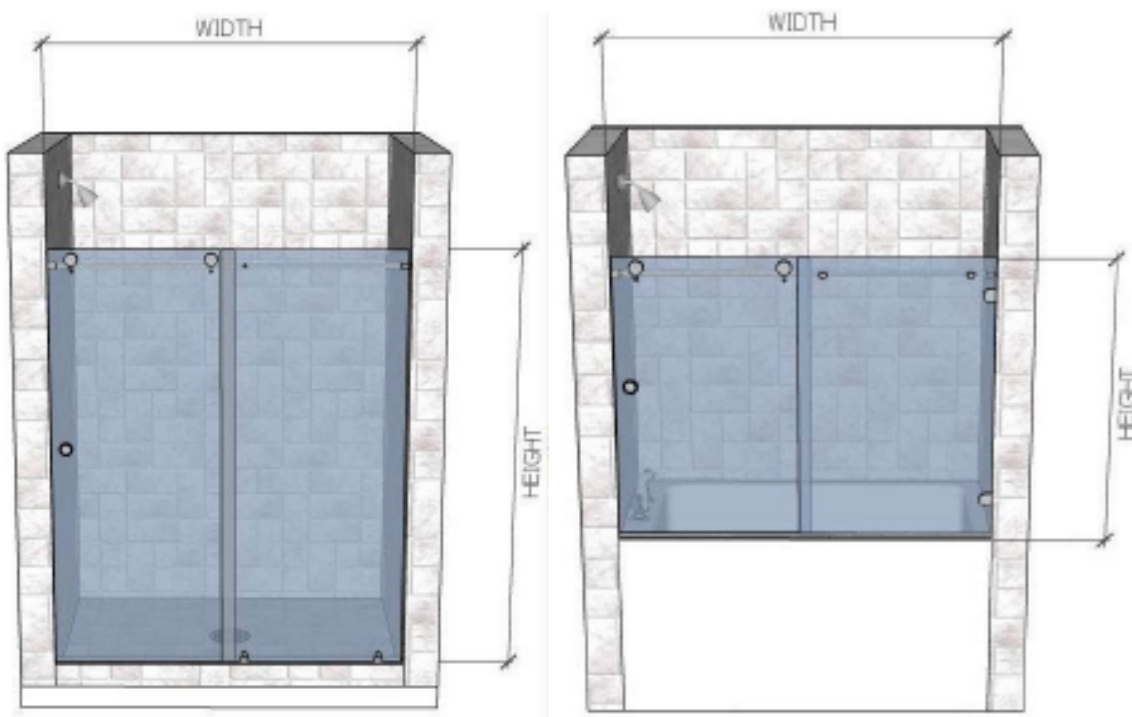

For installation above a ceramic or stone shower base:

Ensure that the BASE WIDTH is of a material that can be drilled and is at least 3" wide. This base will need to be drilled in order to install two glass mounting clamps.

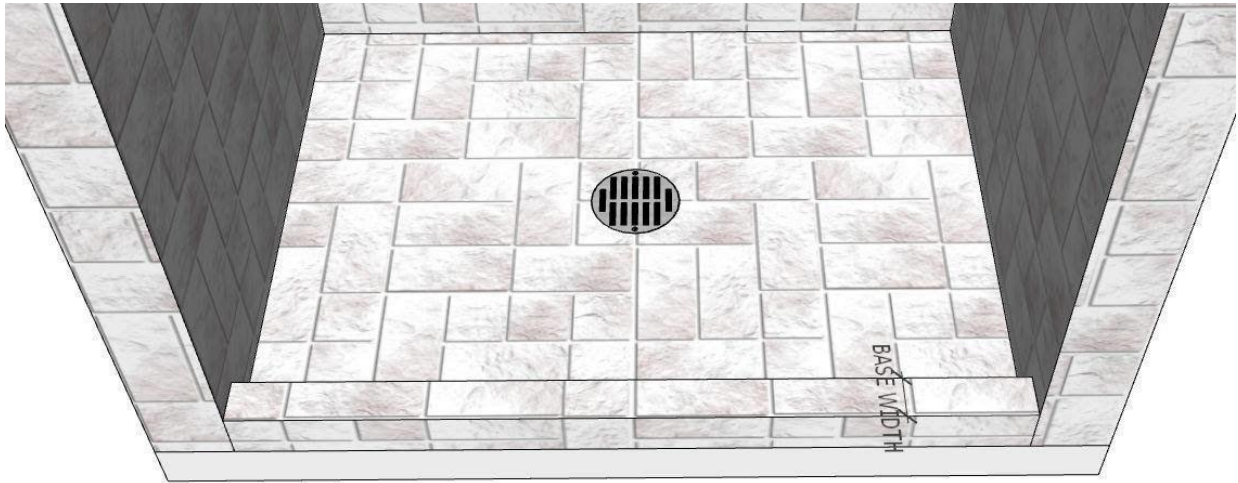

For installation above a bathtub, or above a plastic or acrylic shower pan:

Ensure that the BASE WIDTH is at least 3" wide. This base will accommodate the U-channel that holds the fixed panel, as well as the floor guide that keeps the sliding door in place. The U-channel will be affixed to the tub or shower pan using double-sided tape; no drilling will be required.

Why we're different: *Our double-sided tape installation means no drilling into plastic or acrylic.*

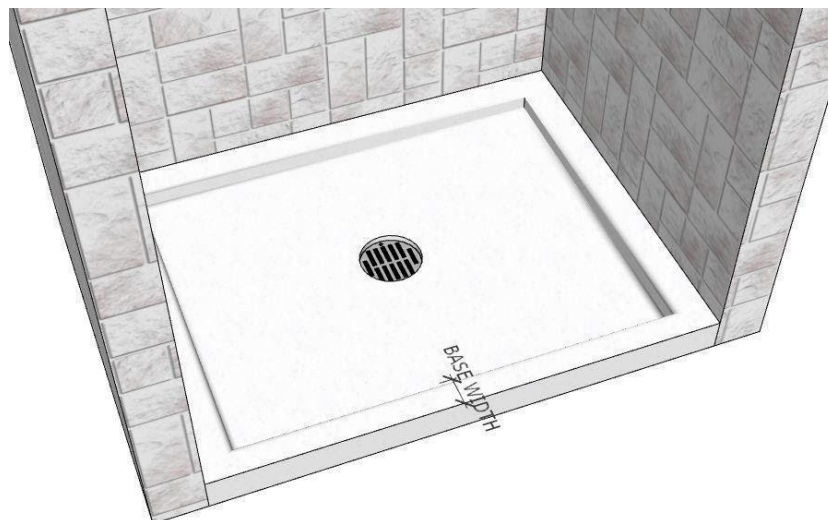
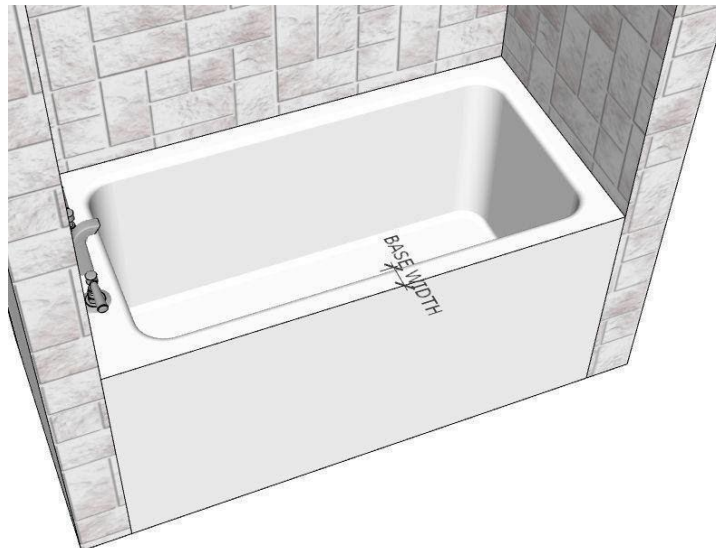

Step 2: Sliding Door Rollers and Handle

The installation includes two glass panels: one sliding door and one fixed panel. Both glass pieces have holes at the top. The sliding door has two small holes and two larger holes. The fixed panel has two small holes.

The fixed panel also has two V-shaped cutouts. For installation above a ceramic or stone shower, the V-shaped cutouts will be along the bottom of the fixed panel.

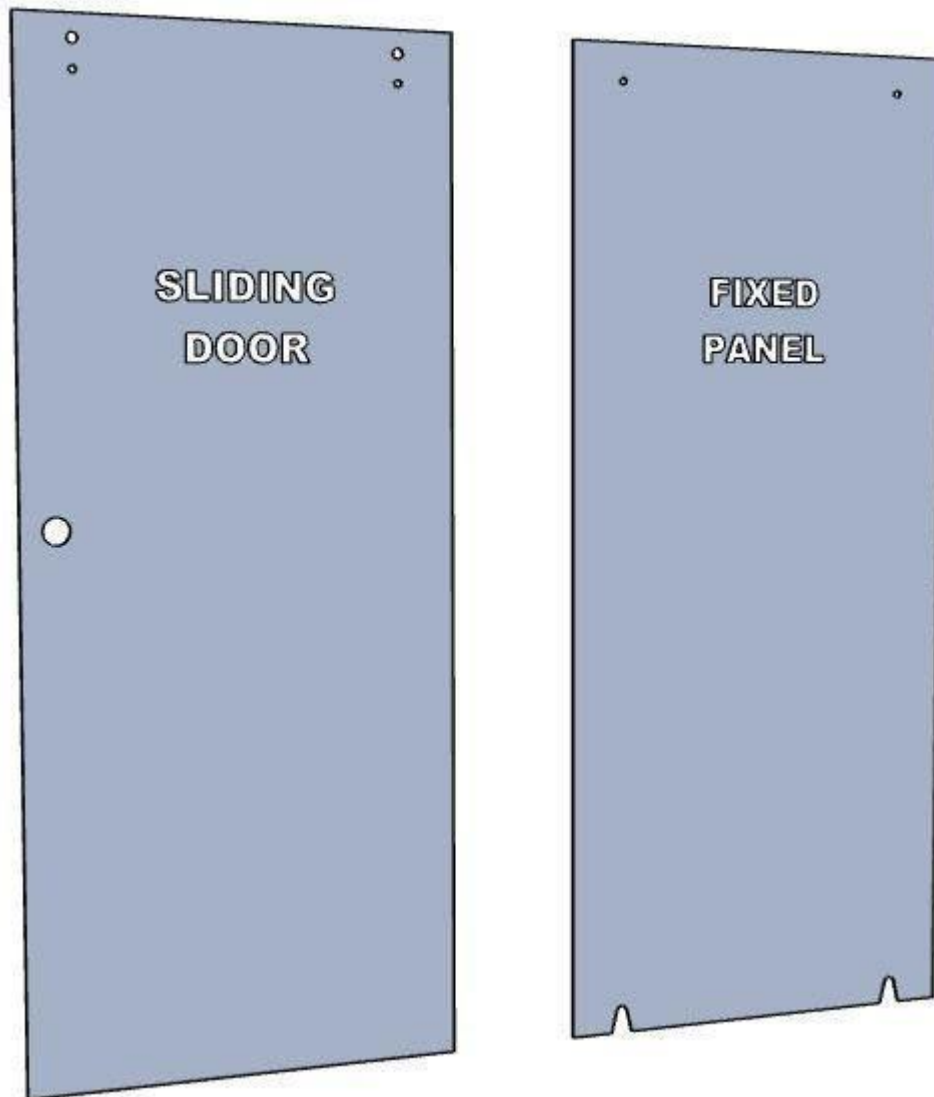

For installation above a plastic or acrylic shower pan, or above a bathtub, the V-shaped cutouts will be along the wall side of the fixed panel.

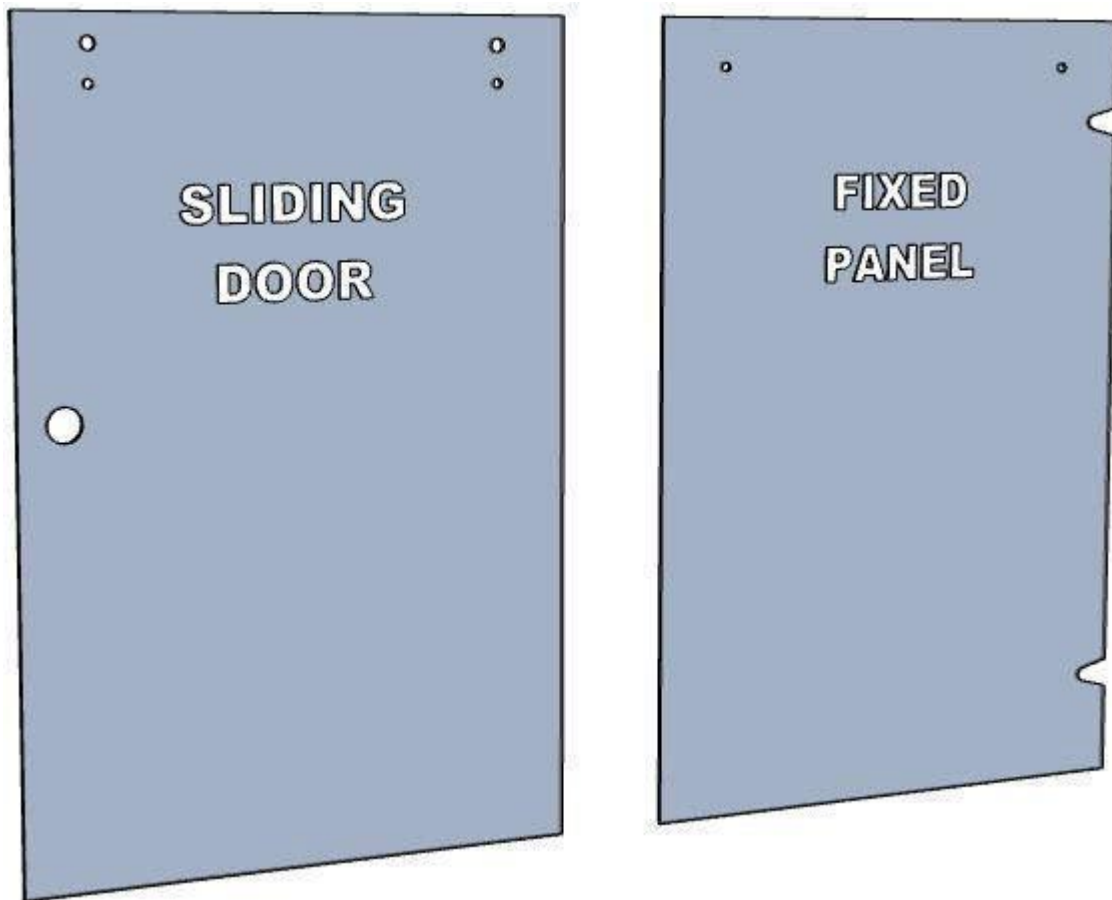

1. Install the rollers in the top two holes of the sliding door.

The rollers use a cam-type motion, with adjusting holes at the high and low points of rotation. Their exact positions will be adjusted after the sliding door is placed atop the bar.

To install the rollers, first use an Allen wrench to loosen and separate the nut from the screw/roller assembly. Be sure that the plastic grommets remain in place - their purpose is to prevent contact between the shower glass and metal.

Then insert the screw part of the assembly through the hole in the glass, and replace and tighten the nut from the opposite side of the glass.

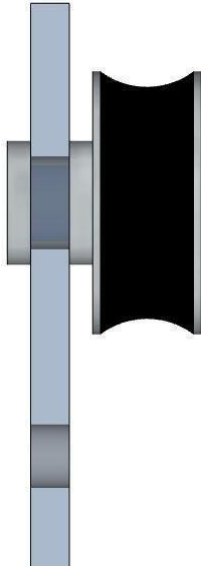
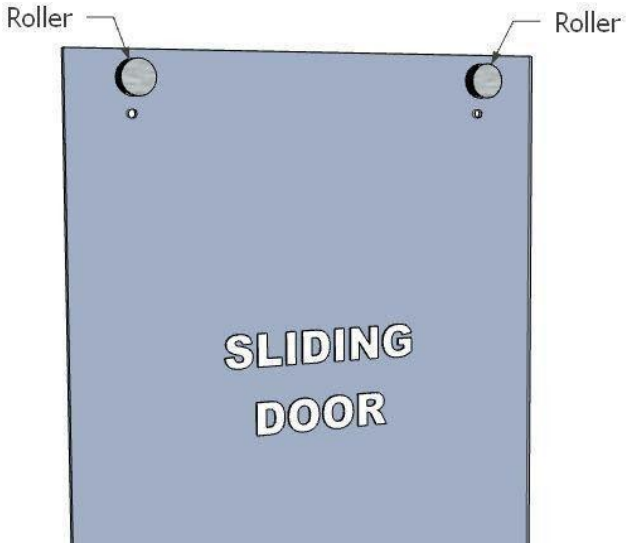

2. Install the recessed pull in the sliding door.

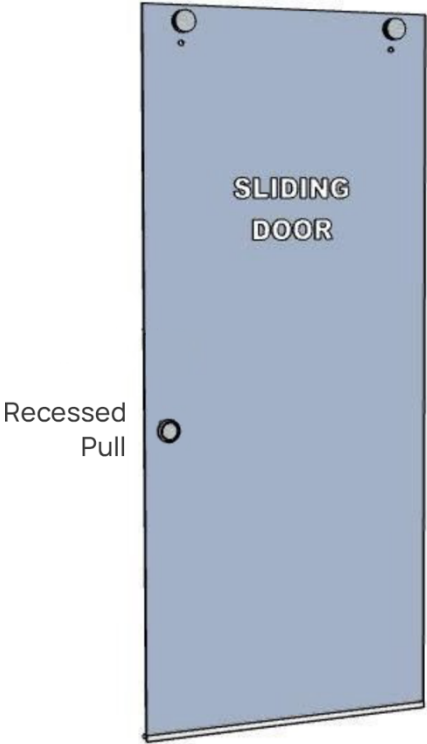

3. At the bottom of the sliding door, attach the bottom sweep. Cut the sweep to fit the width of the door.

METRO SHOW DOOR:
INSTALLATION INSTRUCTIONS

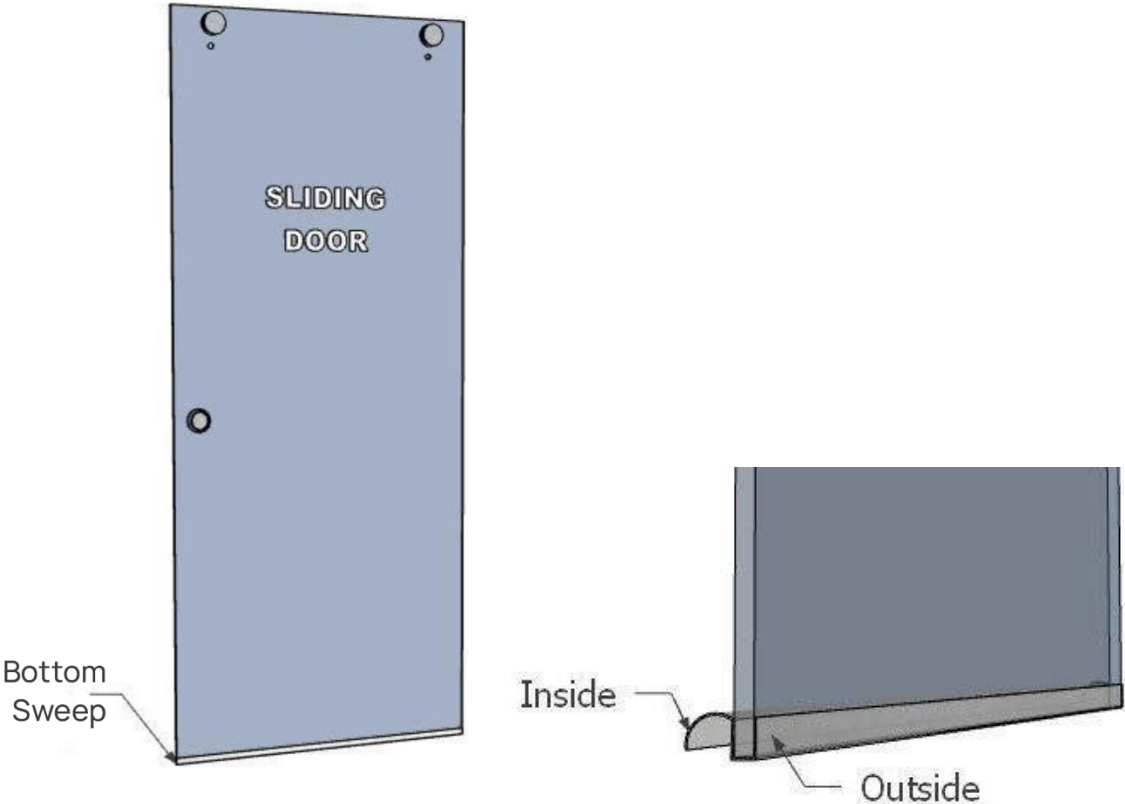

4. Gently place the sliding door, with its three pieces of installed hardware and bottom sweep, inside the shower or bath, leaning against the back wall. Rest the door atop a towel or similar, to prevent contact between the door and the shower / bath floor. Also place a towel or similar between the top of the door and the shower / bath wall.



Step 3: Install the Roller Support Bar

- 1. Along the shower base, or along the center of the tub or shower pan side, mark the centerline.

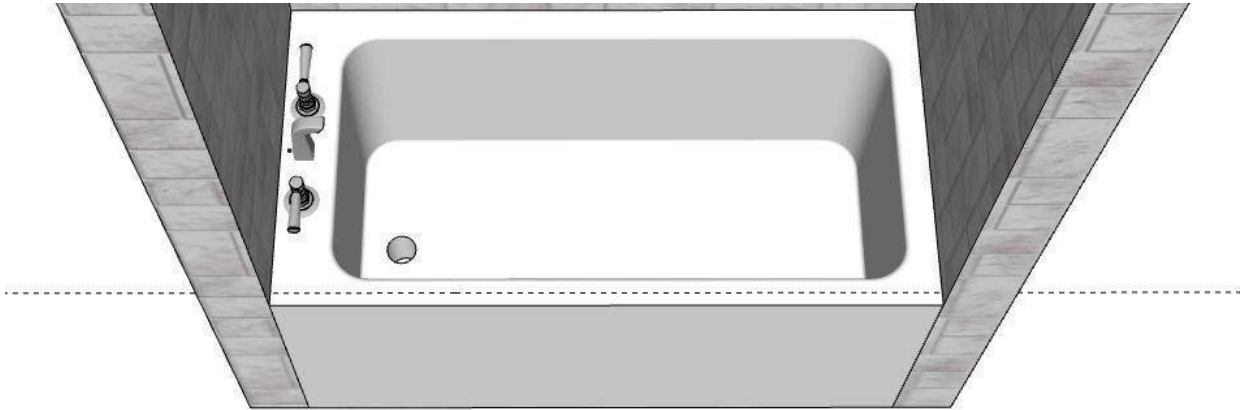
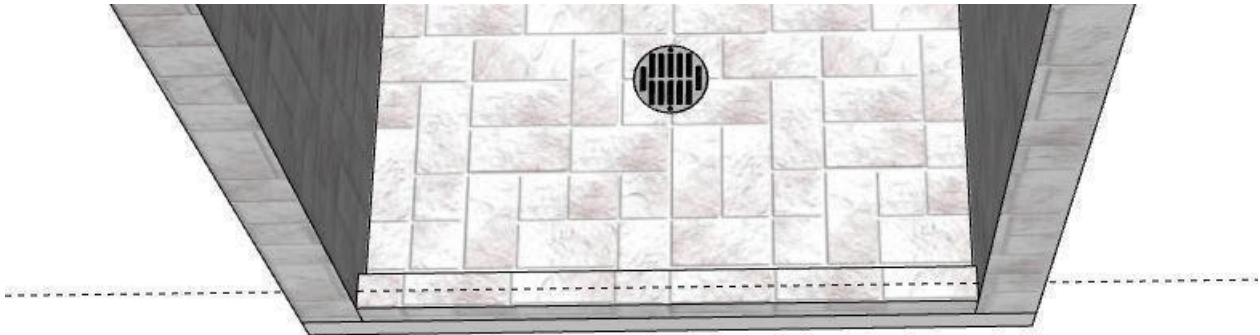

2. From the point where the centerline meets either shower / bath wall, measure straight up to mark the placement of the wall bar brackets. Recalling the HEIGHT measurement taken in Step 1, the distance to measure and mark here is: HEIGHT minus $2\frac{3}{4}$ ".



3. Repeat this measurement and marking for the other side. Use a level to ensure that the two markings are directly horizontal from one another.

4. The wall bar brackets will be used to install the roller support bar. Each bracket consists of two pieces: a puck and collar. Separate these two pieces using the Allen wrench.

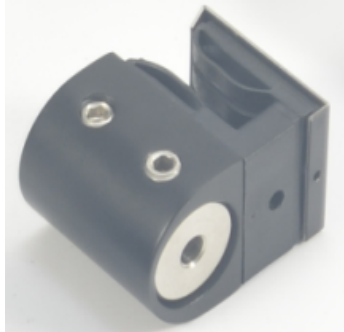

5. Setting the collars aside for now, use screws to install both pucks at the top of each measured mark.

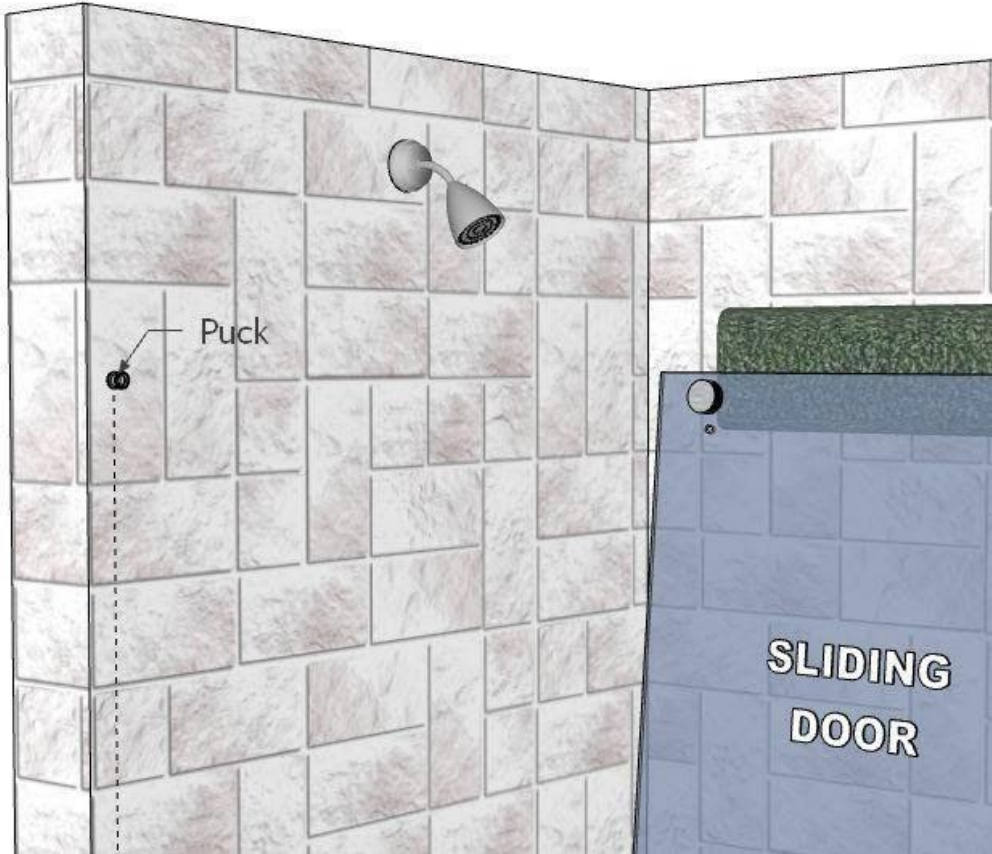

The puck's adjustment slot should be vertical, with the screw centered in the slot.

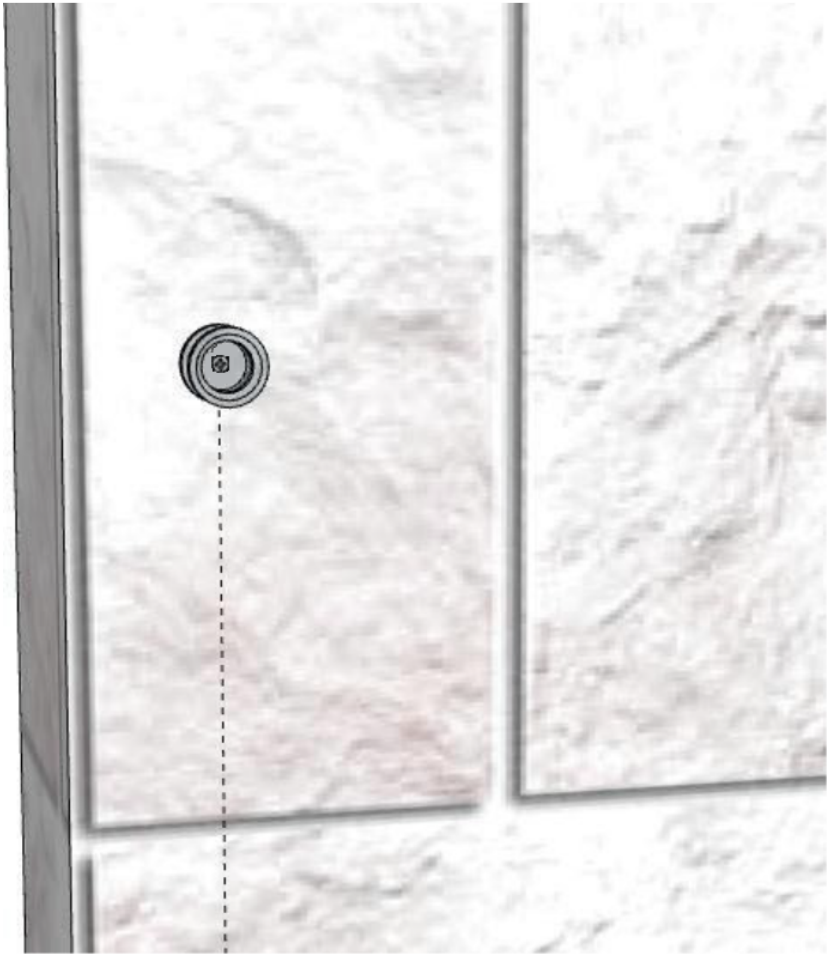

6. Recalling the bath / shower WIDTH measured in Step 1, cut the roller support bar so



that its length equals WIDTH minus 1-5/8".

- Slide both door stops onto the roller support bar, leaving at least 3" of bar on either side. Use painter's tape to temporarily hold the stoppers in place.



- Slide both collars from the wall mount brackets onto both ends of the roller support bar. Use painter's tape here as well, to temporarily hold the collars in place.

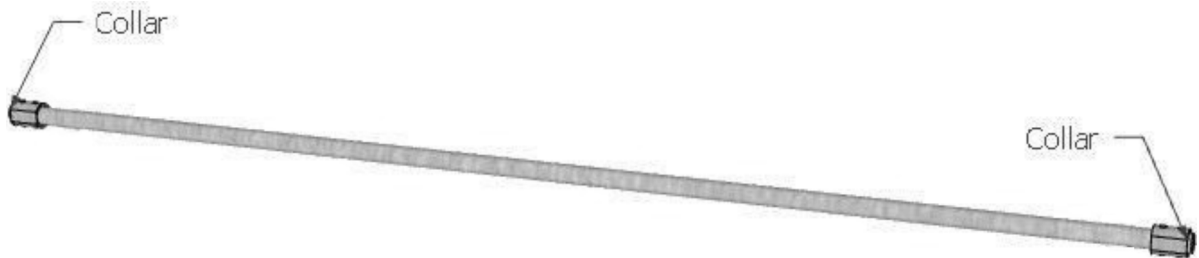

- Hold the roller support bar, with its attached door stops and collars, so that the ends are flush with the pucks on both sides. Check to ensure that the bar is level - if it's not, then adjust the location of one or both pucks.

10. To attach the bar to the walls, slide both collars over their pucks. Tighten the screws to hold the collars in place, which in turn locks the roller support bar into position.

On the sliding door side, the flat face of the collar should be vertical, facing into the shower.

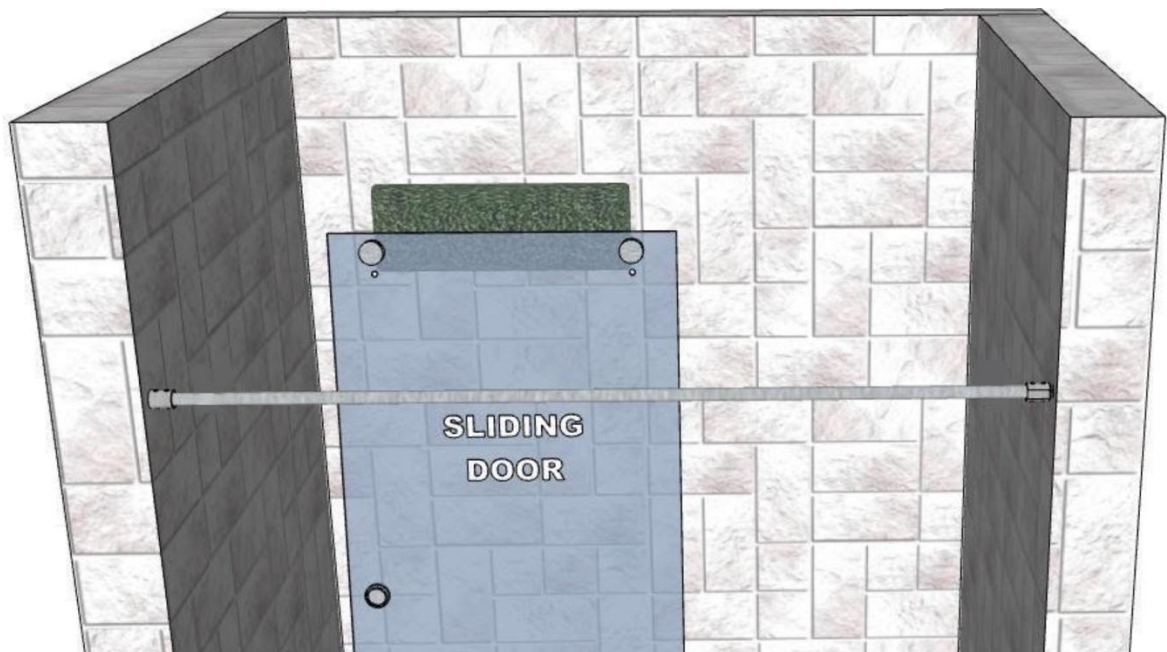

METRO SHOW DOOR:
INSTALLATION INSTRUCTIONS

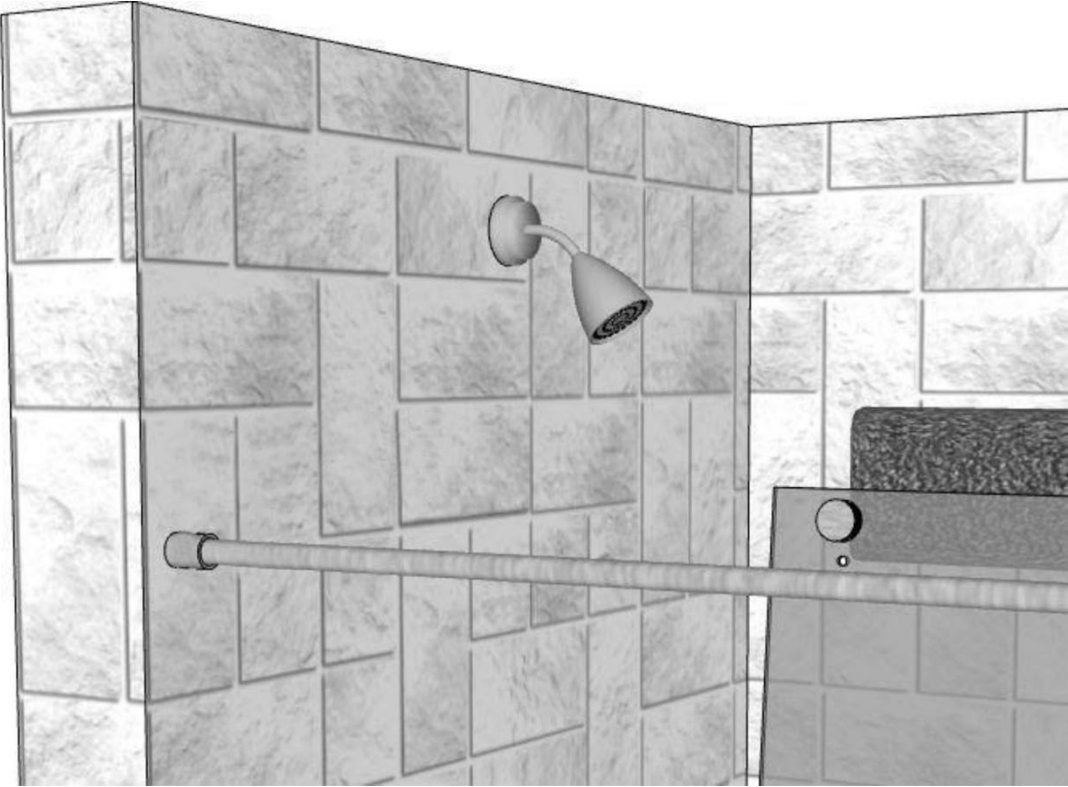

On the fixed panel side, the flat face of the collar should be vertical, facing outside the shower.

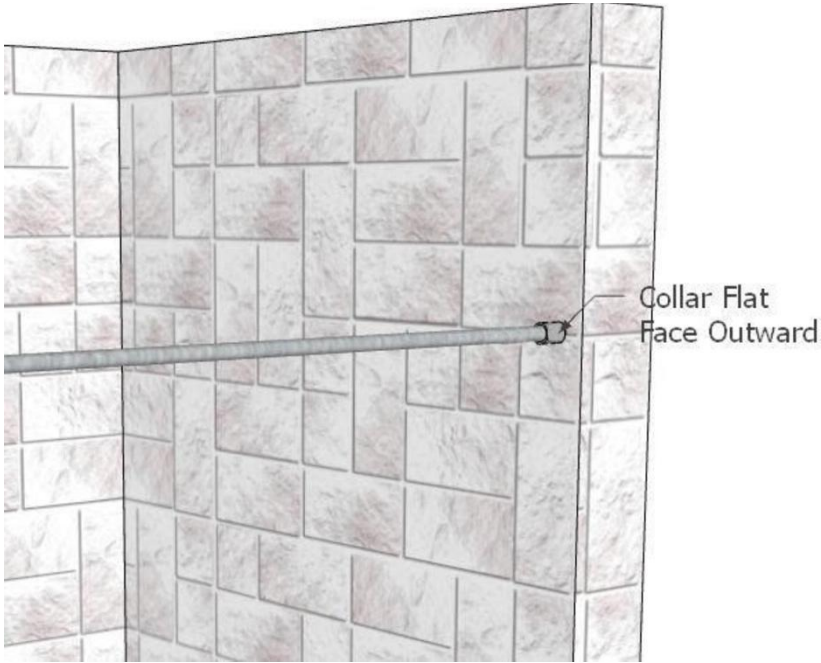

Why we're different: Our collar and puck system provide wiggle room for the roller support bar, allowing for slight discrepancies in roller support bar length.

Step 4: Install the Fixed Panel Support (Ceramic / Stone Shower Base)

(For plastic / acrylic shower pan or tub installation, skip to the next Step 4.)

For a ceramic or stone shower base, the fixed panel is held along the bottom by two glass mounting clamps.

1. The glass mounting clamps are to be placed directly below the V-shaped cutouts along the bottom of the fixed panel. Measure and mark these locations accordingly.

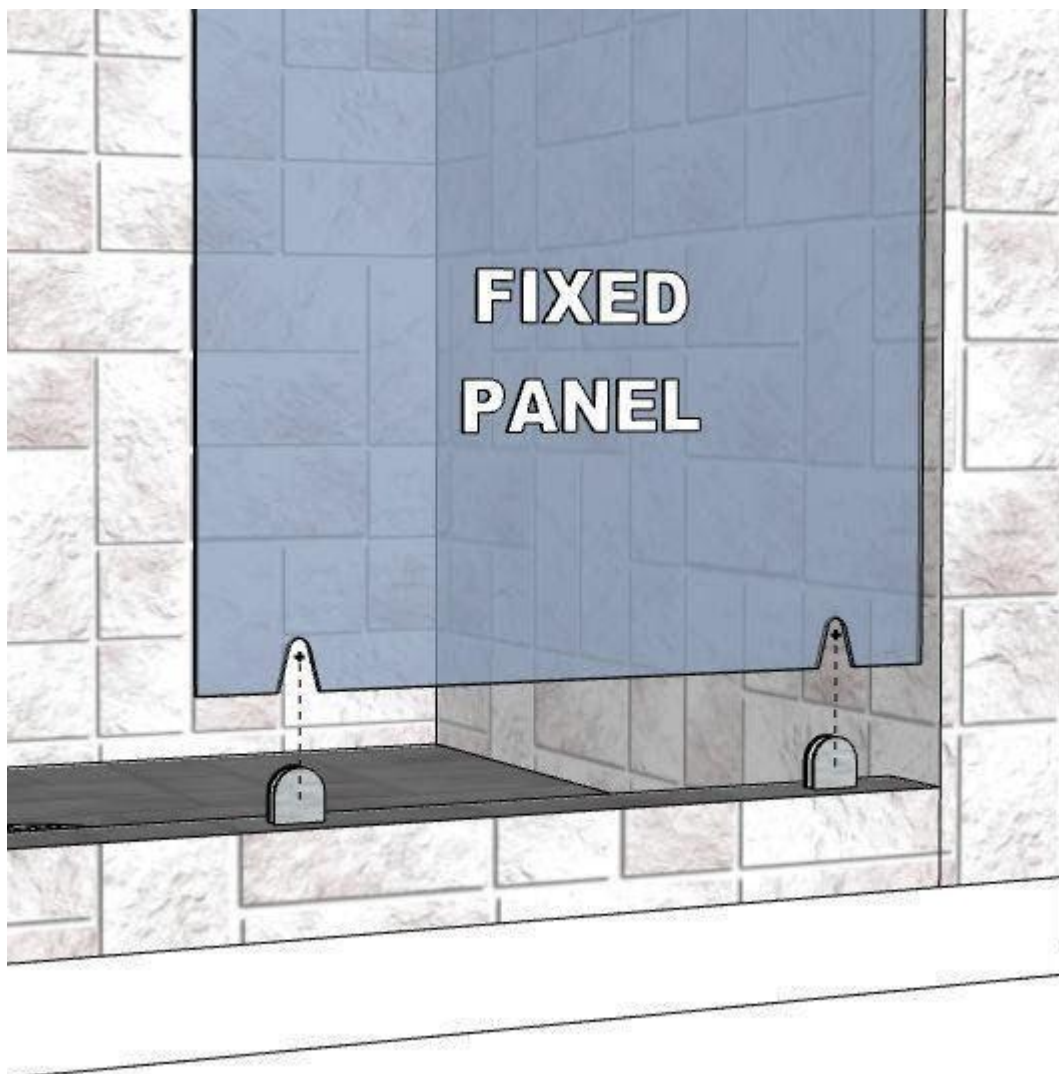

2. Along the shower base, the glass mounting clamps are to be placed at a $\frac{3}{4}$ " outside offset from the center of the base. Again, mark this location accordingly.

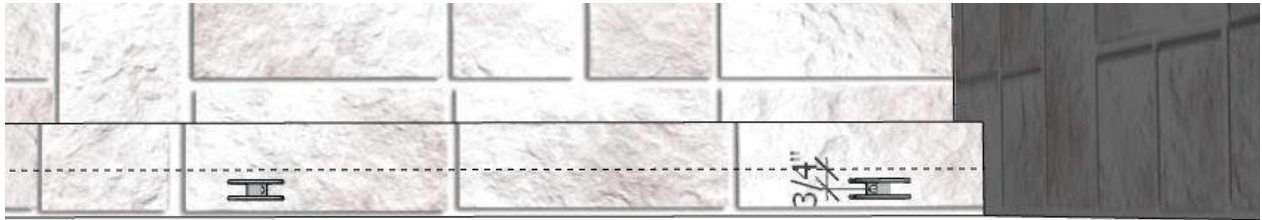

3. The glass mounting clamps consist of a front and back, connected by a screw. Unscrew to separate the two parts of the clamp. Set aside for now the front of the clamp - this is the part with the solid, smooth face. (The clamp fronts will be reattached after the fixed panel is installed.) Drill to attach the back of each clamp to the shower base.

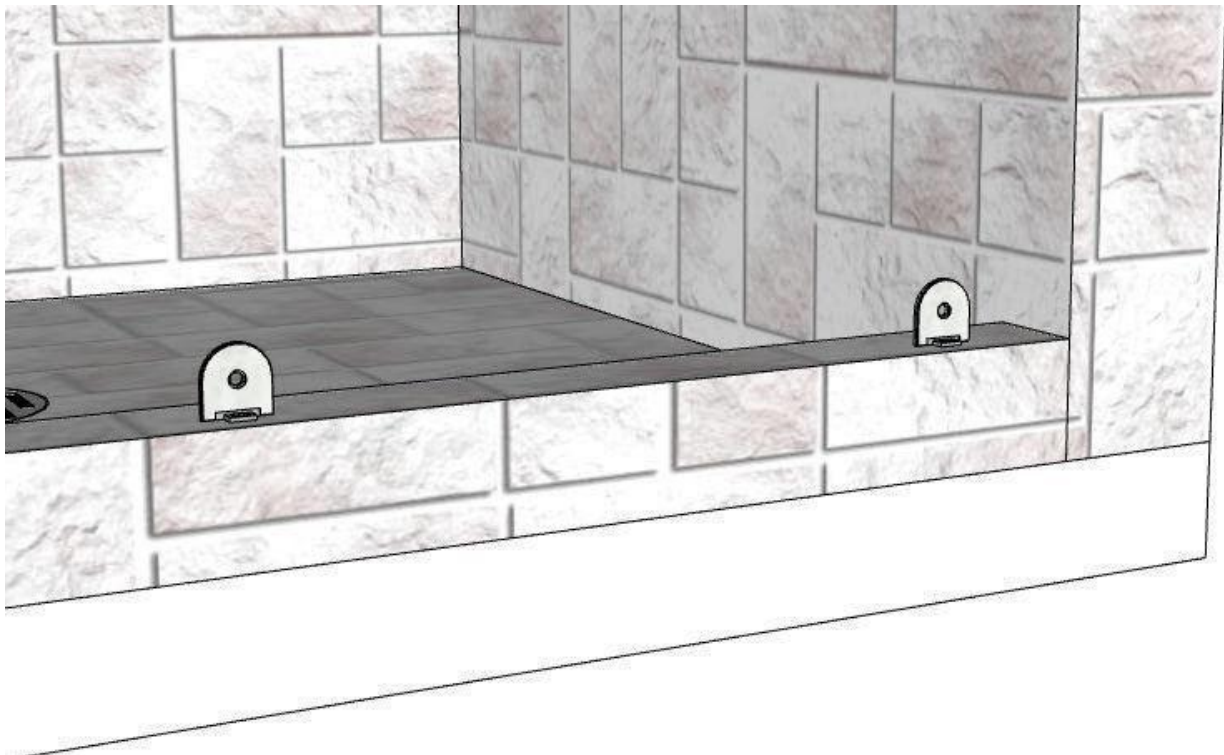

Step 4: Install the Fixed Panel Support (Plastic / Acrylic Shower Pan or Tub)

For a plastic or acrylic shower pan, or bathtub, the fixed panel is attached to the shower / bath wall by two glass mounting clamps. The fixed panel is attached to the shower / bath base with by a U-channel.

1. The U-channel must be $\frac{7}{8}$ " shorter than the width of the fixed panel. Cut the U-channel to its correct length.

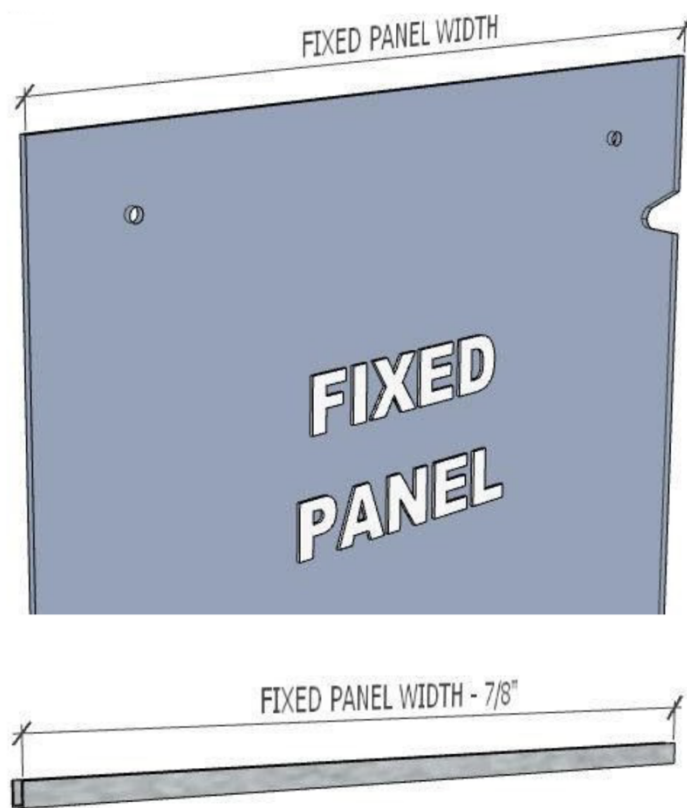

2. Along the tub / shower base, the U-channel is to be placed at a $\frac{3}{4}$ " outside offset from the base center. Mark the U-channel centerline.

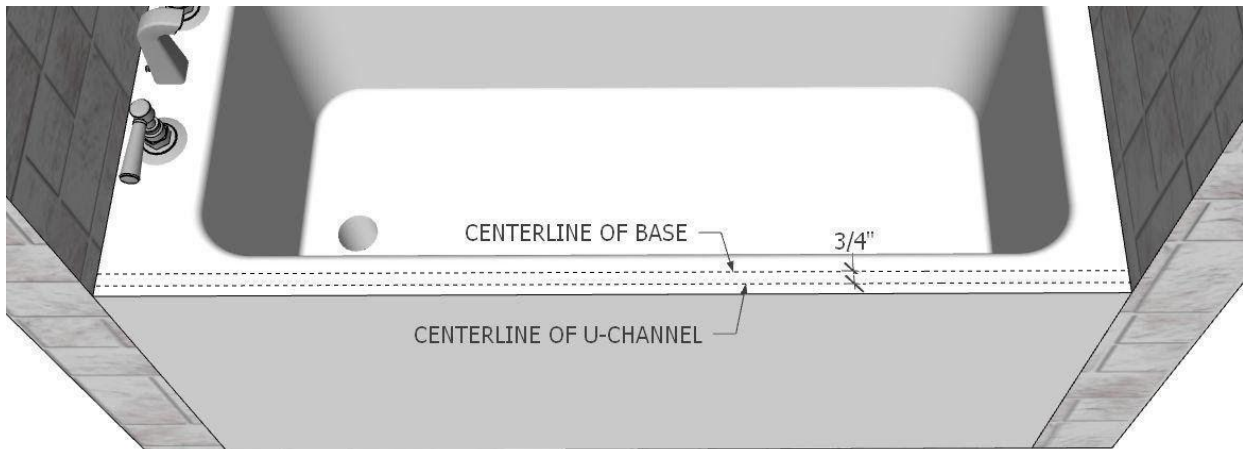

3. Using double-sided tape (not provided), affix the U-channel along its centerline, on the side where the fixed panel will go. The U-channel should meet the wall.



The glass mounting clamps are to be placed directly to the right or left (depending on your wall side) of the V-shaped cutouts along the side of the fixed panel. Temporarily place the fixed panel inside the U-channel, ensure that the panel is perfectly vertical, and measure and mark the centers of the cutouts.

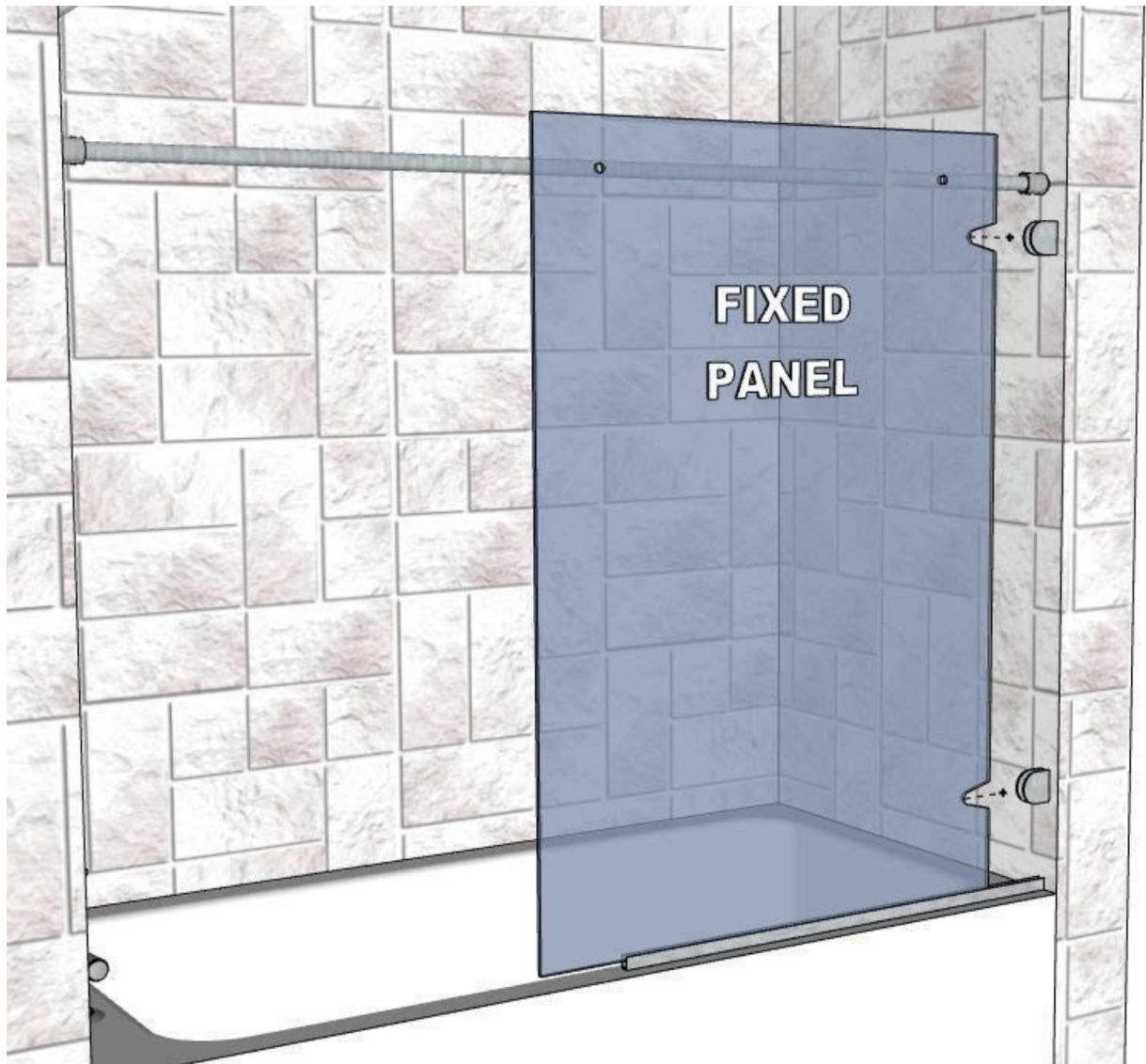

4. Remove the fixed panel for now.

5. The glass mounting clamps consist of a front and back, connected by a screw. Unscrew to separate the two pieces of the clamp. Set aside for now the front of the clamp - this is the part with the solid, smooth face. (The clamp fronts will be reattached after the fixed panel is installed.) Drill to attach the back of each clamp to the wall.



METRO SHOW DOOR:
INSTALLATION INSTRUCTIONS



(Close-up view of one glass mounting clamp, with front removed and set aside.)



Step 5: Install the Fixed Panel

1. Loosely attach the two fixed panel clamps to the roller support bar, on the side of the fixed panel, on either side of the door stop. The round screw front should face outside the shower/bath.

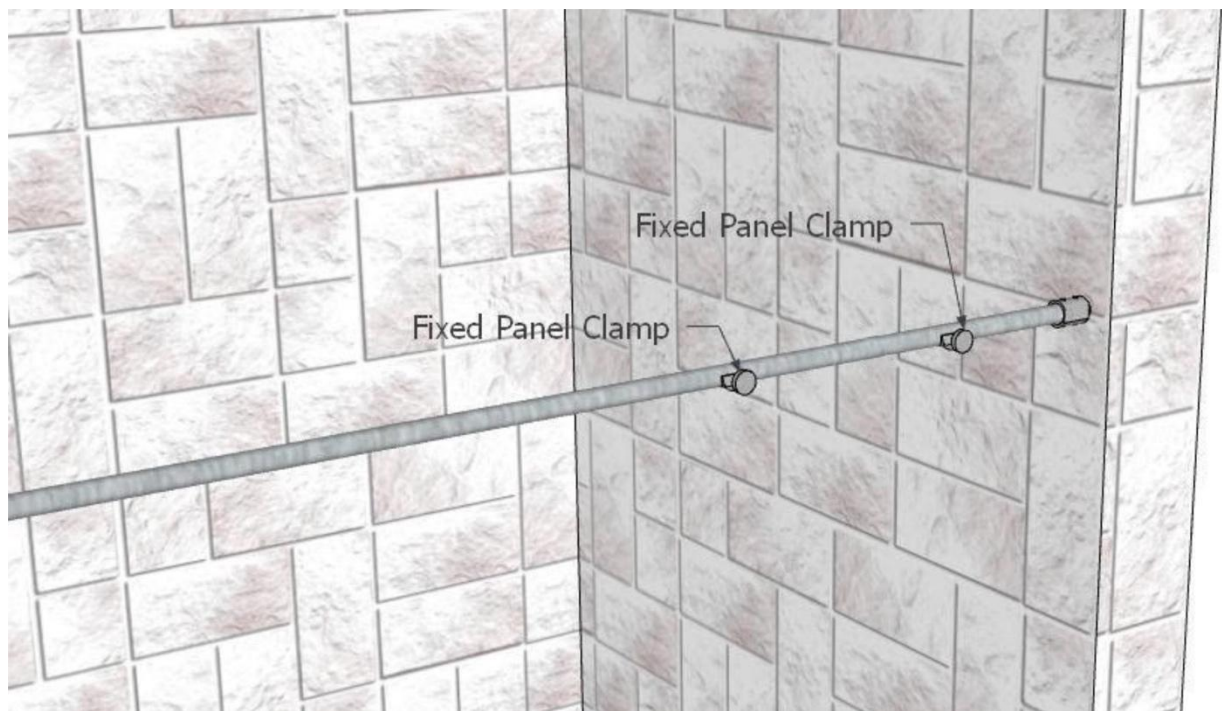



- 2. Remove and set aside the front screws from both glass fixed panel clamps.

- 3. **Ceramic/stone shower installation:**

METRO SHOW DOOR:
INSTALLATION INSTRUCTIONS



Place one shim on either side of the glass mounting clamps. These shims should be about 1" inward from the sides of the fixed panel.



Tub / shower pan installation:

Place one shim on either side of the U-channel. These shims should be no more than 1" inward from the ends of the channel.



Use painter's tape to temporarily attach two shims to the fixed panel side of the wall,

approximately aligned with the top and bottom of the fixed panel.

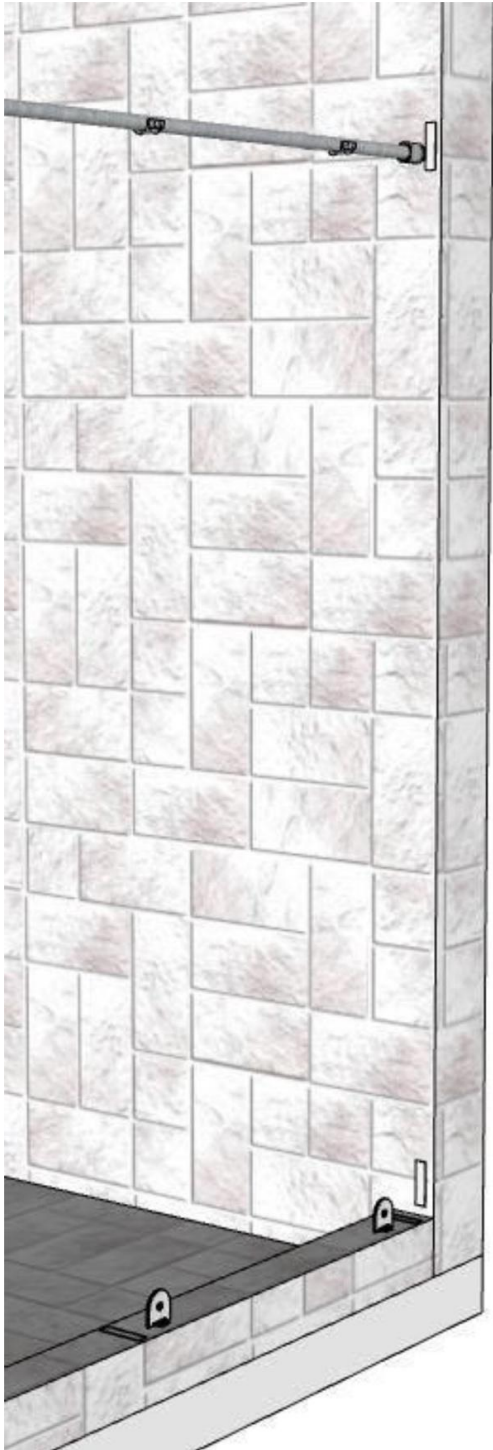

4. **Ceramic / stone shower installation:**

Gently place the fixed panel in front of the back parts of the glass mounting clamps. The wall side of the fixed panel should **be** flush against the wall. If the panel isn't perfectly level, insert additional shims as needed. At the top, the fixed panel can rest temporarily against the roller support bar.

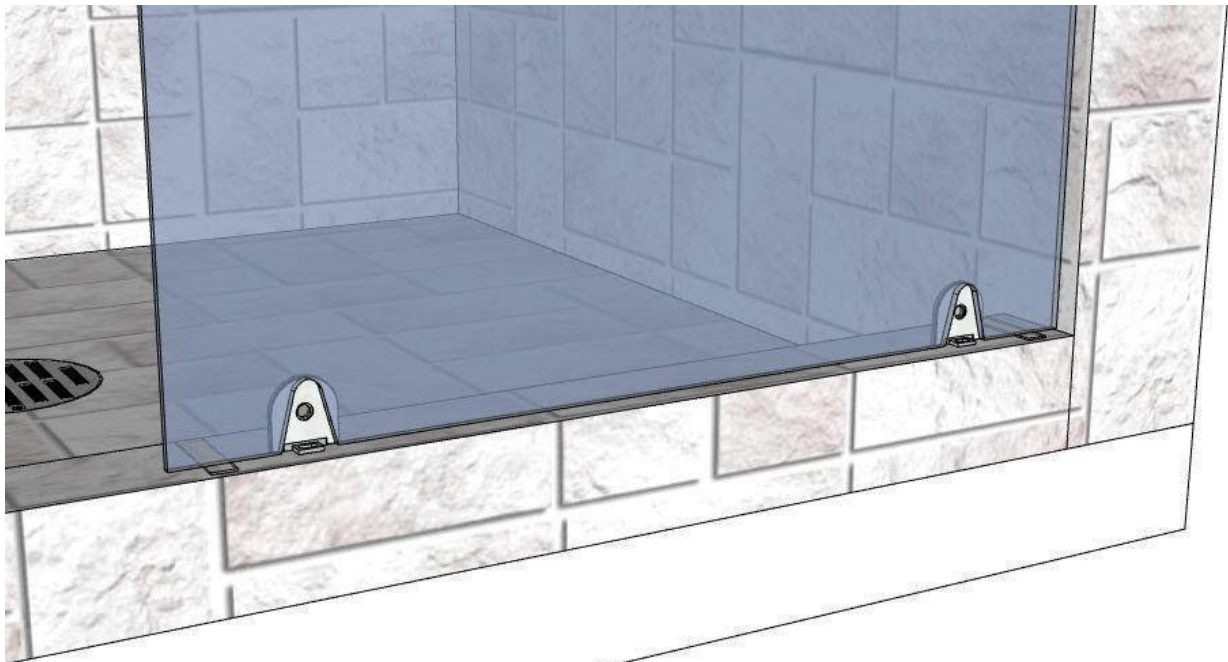

Tub / shower pan installation:

Gently fit the fixed panel into the U-channel. If the panel isn't perfectly level, insert additional shims as needed. The wall side of the fixed panel should rest against the back parts of the glass mounting clamps.



5. Position both fixed panel clamps so that they line up with the two small holes at the top of the fixed panel. The clamp threads should protrude through the holes in the panel.



1. Re-attach the front screws of the fixed panel clamps.

METRO SHOW DOOR:
INSTALLATION INSTRUCTIONS

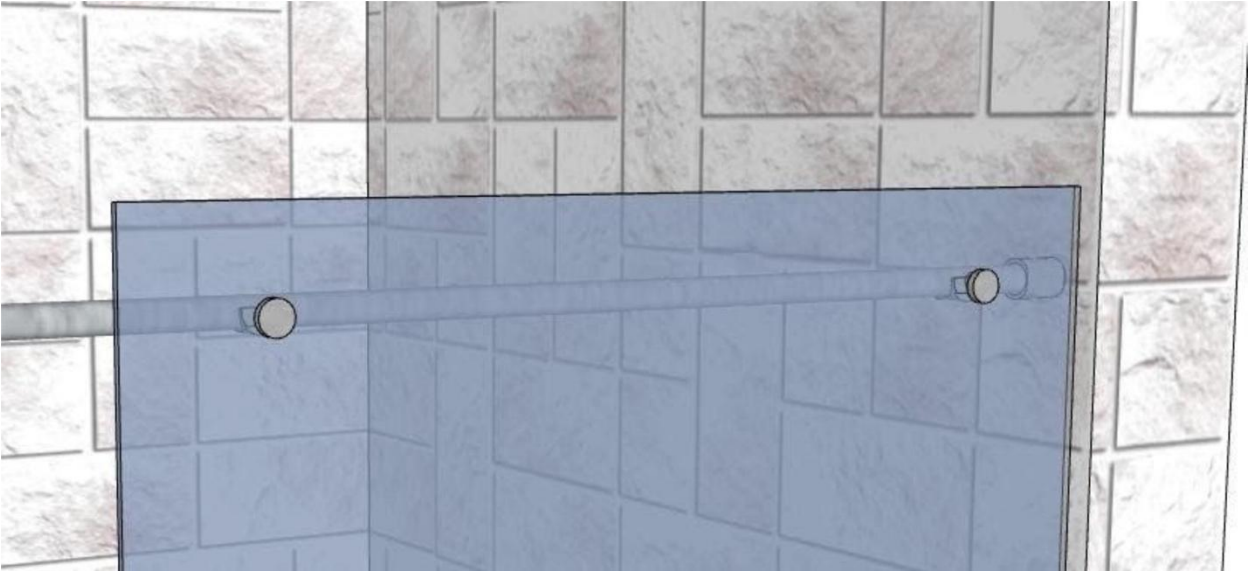

- 1. Re-attach the front parts of both glass mounting clamps.

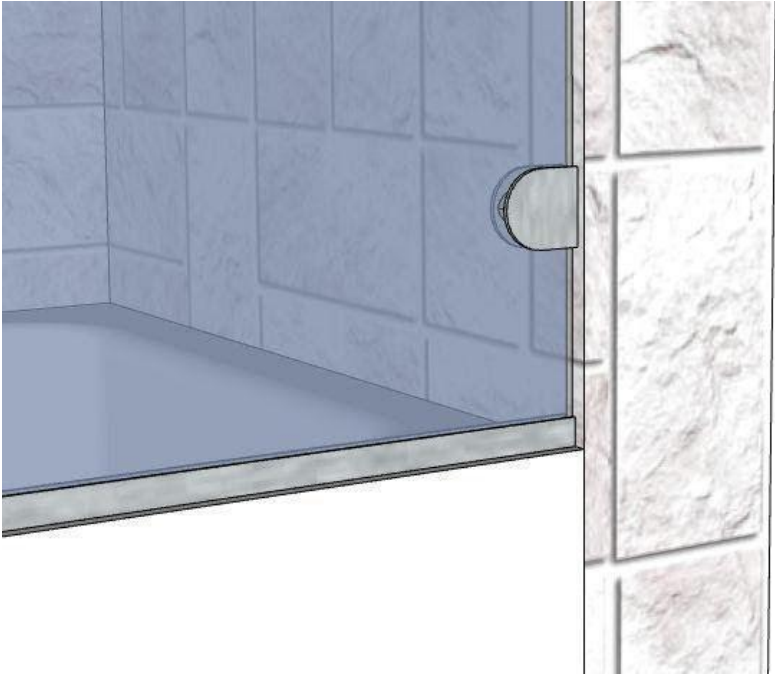

- 2. Remove the shims and tape from the wall.

Step 6: Install the Sliding Door

1. The floor guide must be positioned so that the back part will hold the sliding door, and the front part will attach directly to the fixed panel. If your floor guide is oriented correctly, skip to Step 3. If you need to reverse the direction of your floor guide, first use an Allen wrench to remove the glass attachment screw from the front of the floor guide.

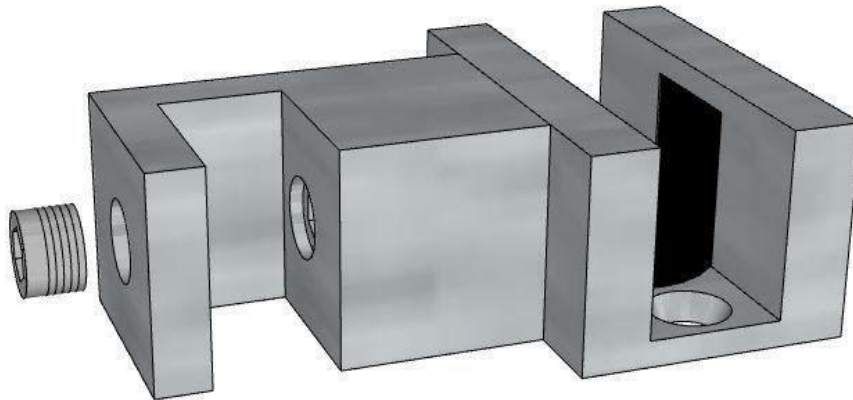

2. Use the Allen wrench again to access the screw connecting the back and front parts of the floor guide. Loosen this screw just enough so that the front part can be turned 180 degrees, then re-tighten. Re-attach the removed glass attachment screw.

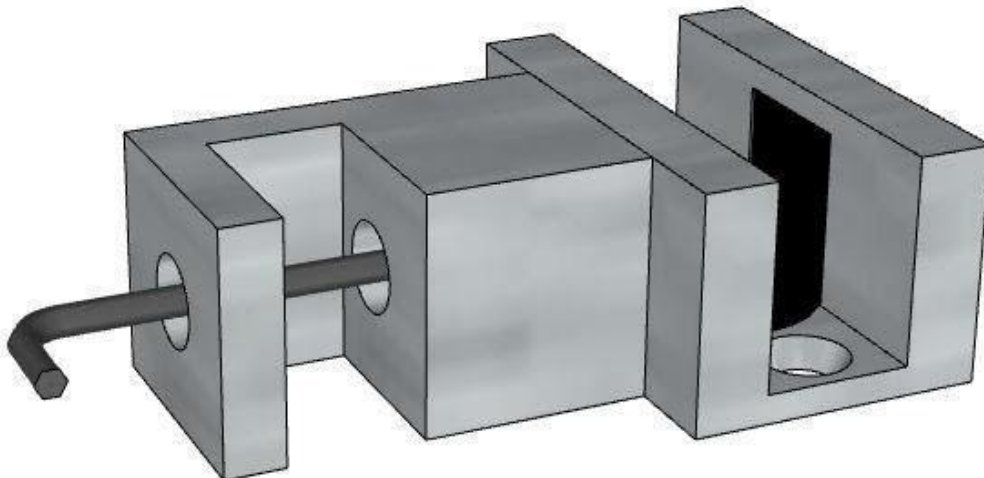

3. Position the floor guide along the center of the shower / tub base. The back part of the guide will hold the sliding door, and the front part attaches directly to the fixed panel.

Insert shims as needed to ensure a tight fit, and slide the guide onto the bottom corner of the fixed panel.

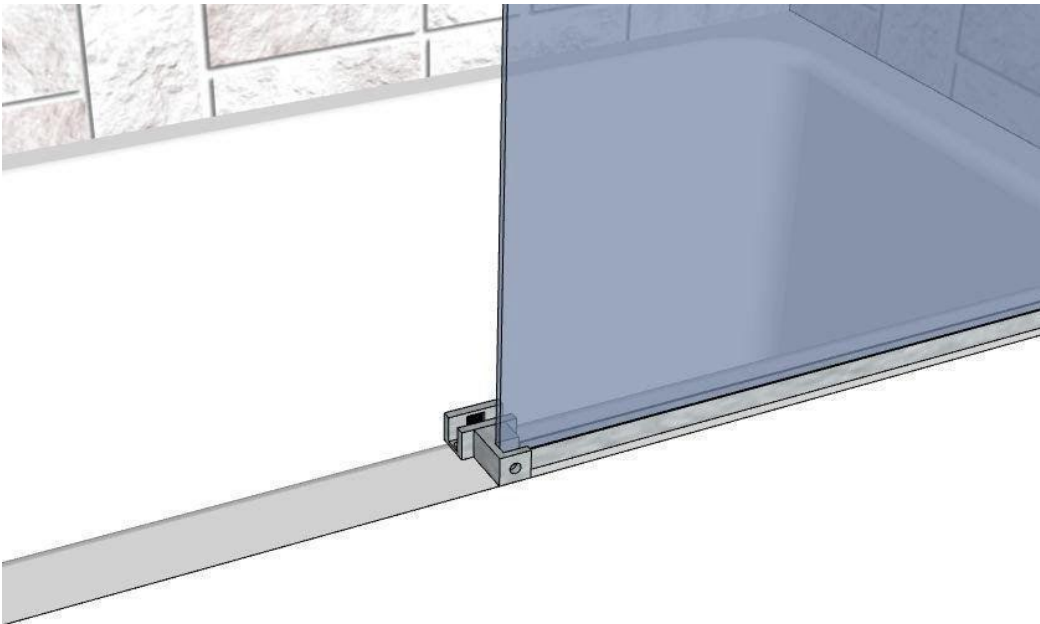
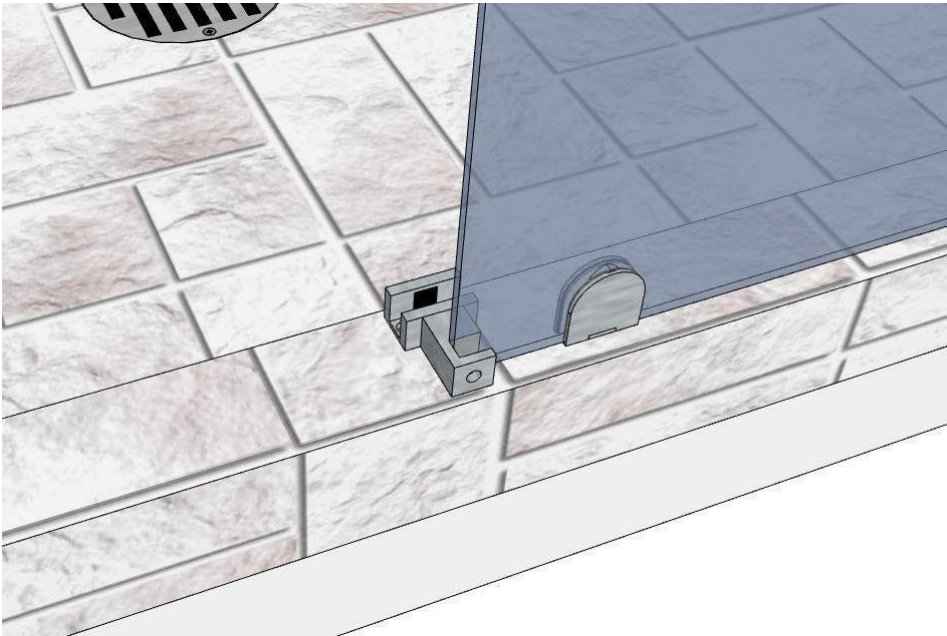

Why we're different: Our floor guide hardware requires no vertical drilling.

4. **This step generally requires two people.** Gently lift the sliding door from where it's resting along the back of the shower / tub. Place the bottom of the sliding door inside the back of the floor guide.

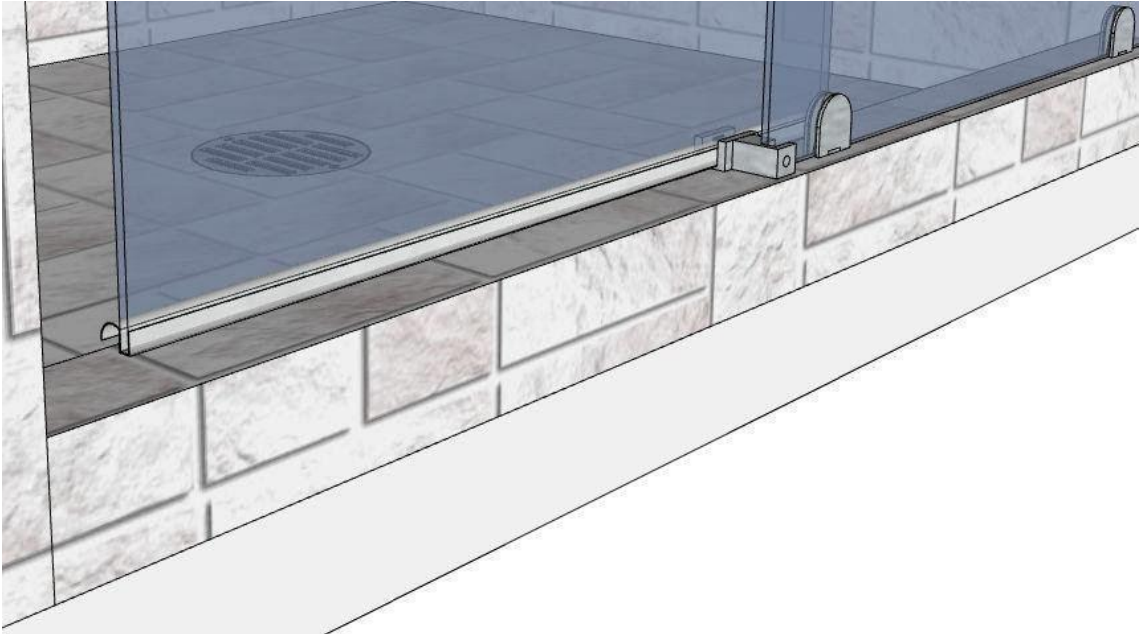

At the same time, hang the sliding door on the roller support bar, with the rollers resting atop the bar. The door stop on the sliding door side should be all the way at the end of the bar.

- 5. In the two holes below the rollers, install the anti-lift fittings. This hardware keeps the sliding door from rising above or off the bar.



6. On the fixed panel side, move the door stop all the way to the fixed panel clamp on the wall side.

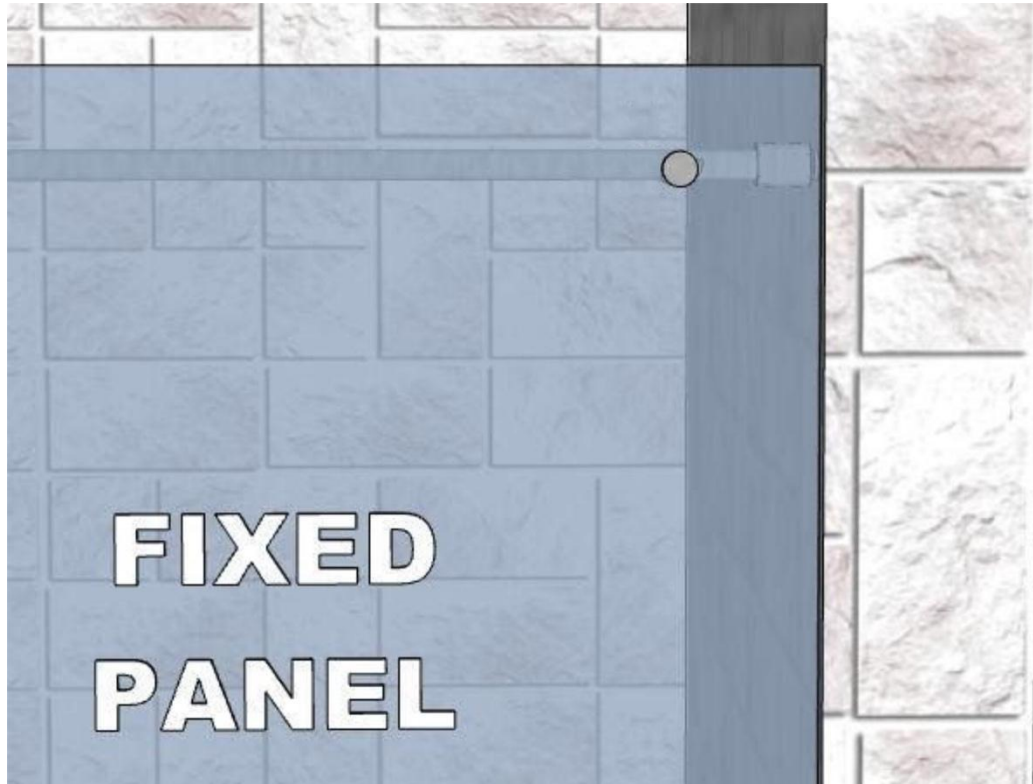



7. Test the side-to-side movement of the sliding door, ensuring that it cannot move past the door stops on either side at the top, and that it remains inside the floor guide at the bottom.

METRO SHOW DOOR:
INSTALLATION INSTRUCTIONS

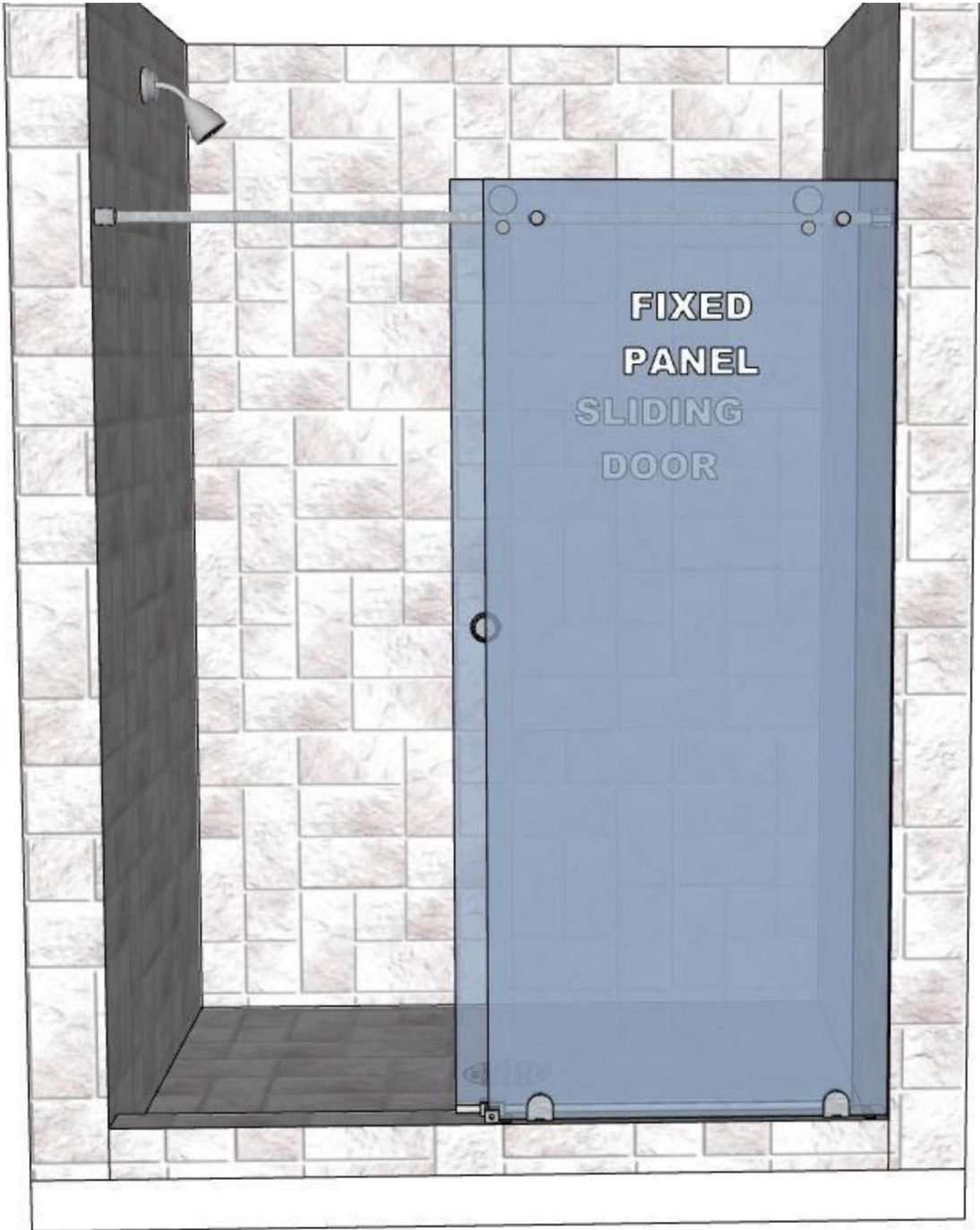

Step 7: Seals and Threshold

1. Cut the bulb seal to fit the height of the sliding door. On the wall side of the sliding door, attach the bulb seal to the sliding door along its entire height.

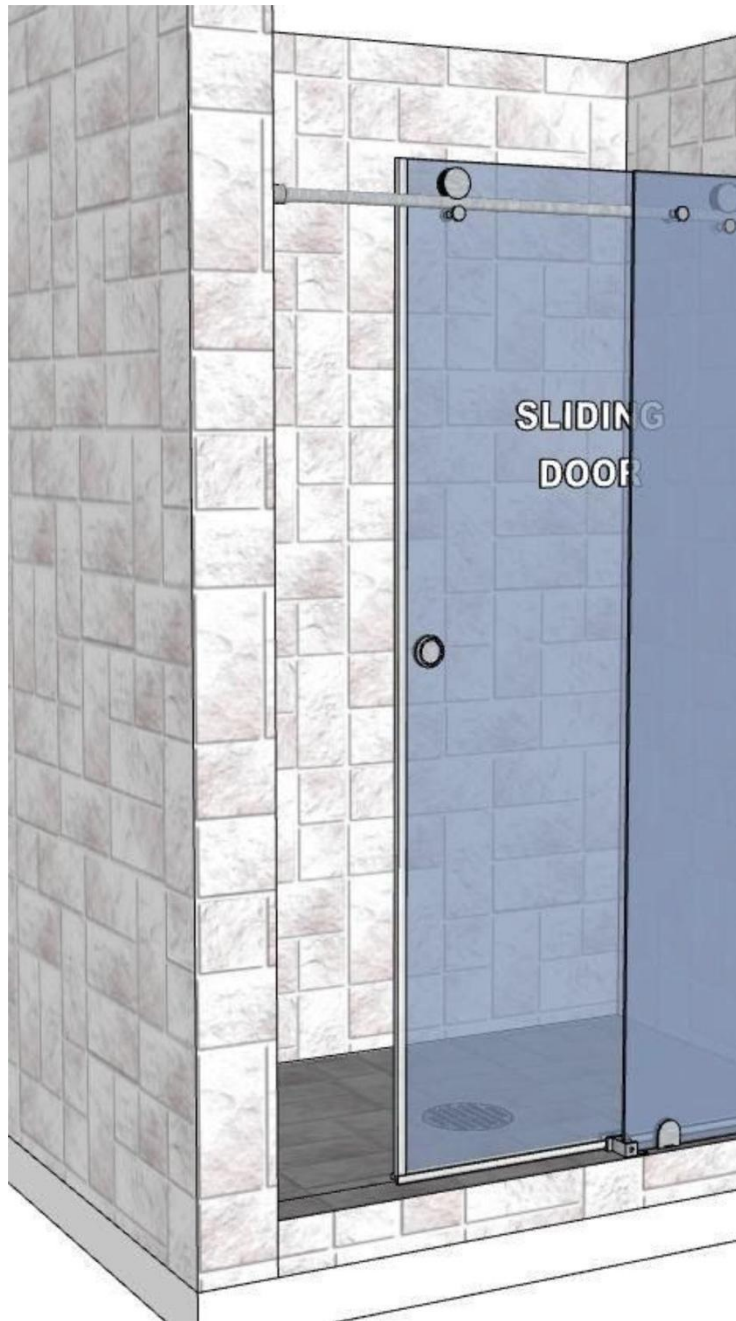

(Top view of bulb seal attached to sliding door)

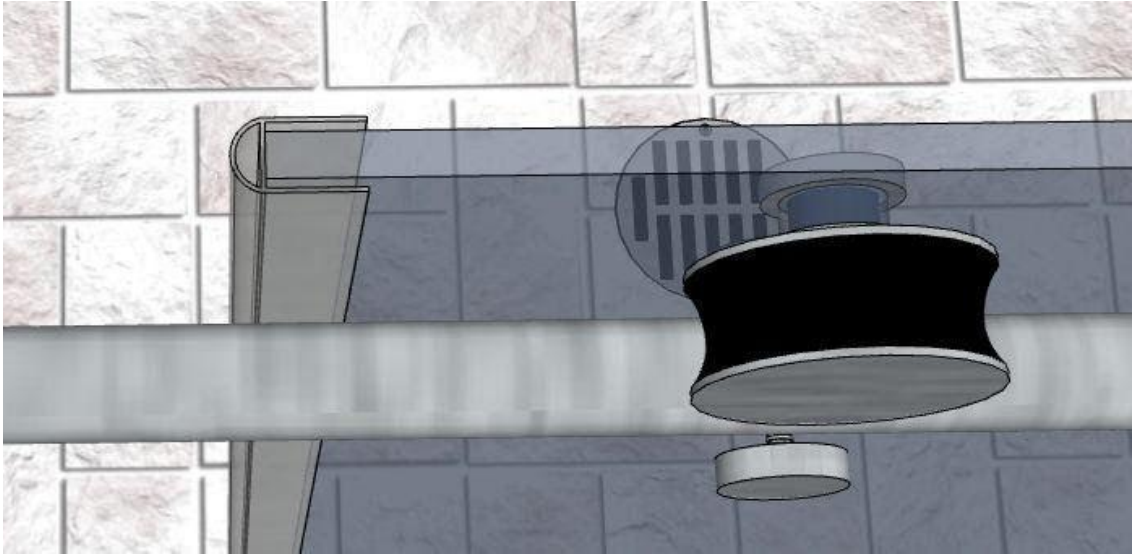

- 2. At the bottom of the sliding door, use a vinyl cutter or utility knife to cut a small notch in the bulb seal, to accommodate the bottom sweep.

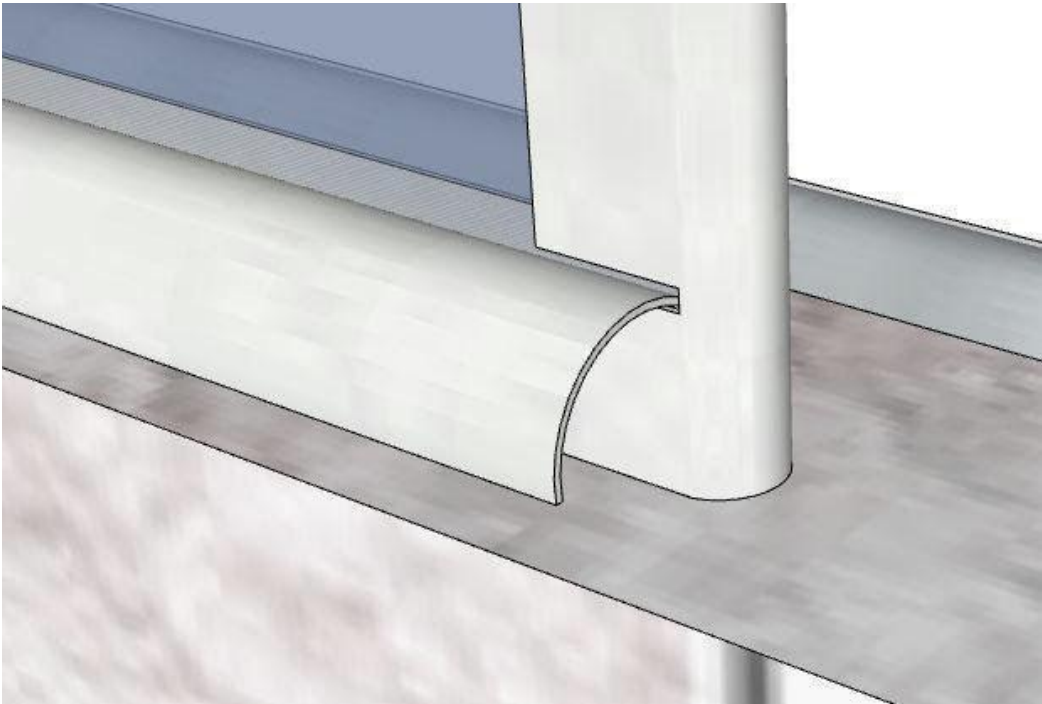

- 3. Attach the vertical soft-edge PVC to the fixed panel on the side of the sliding door.

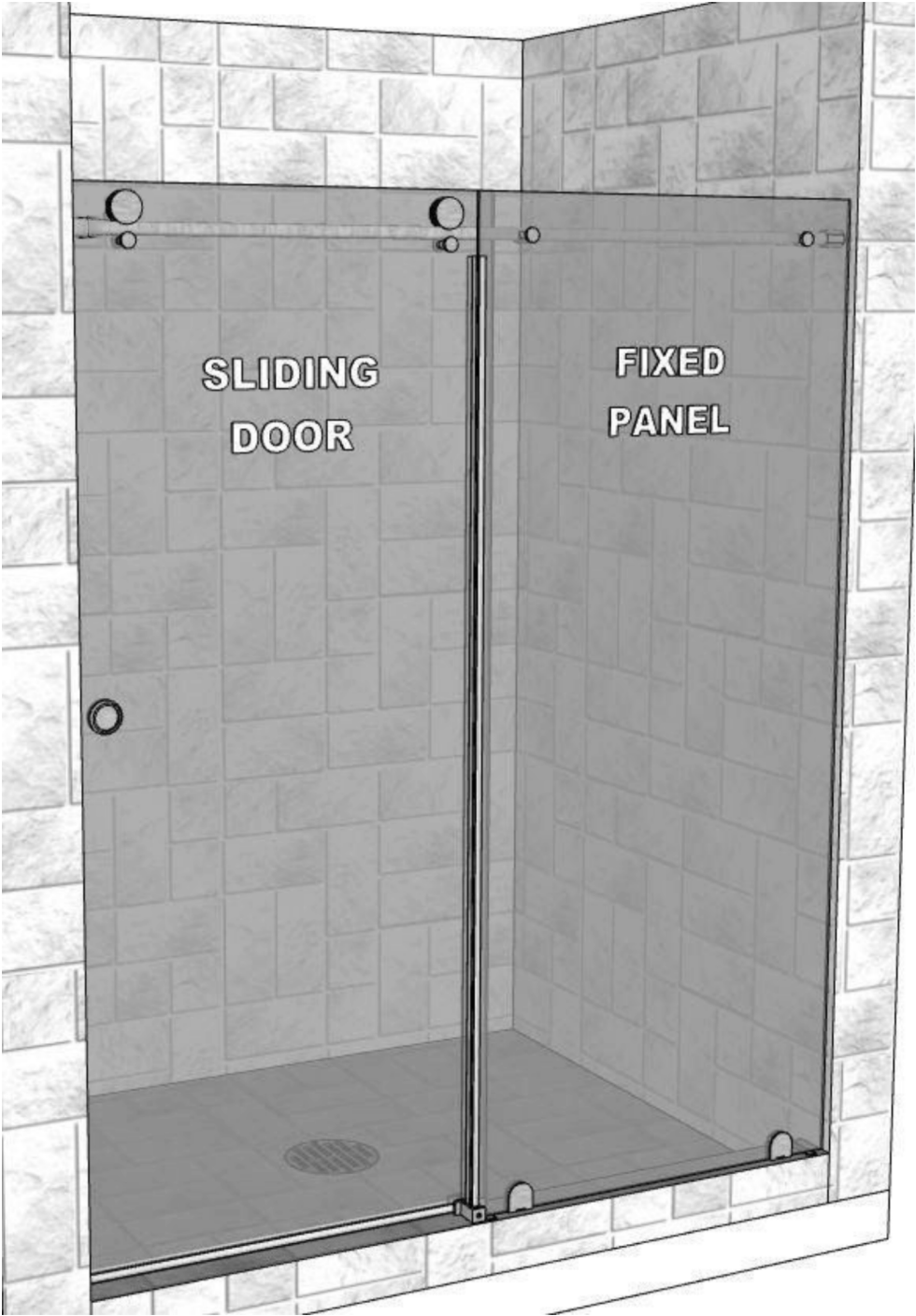

At the bottom, the PVC should be cut to meet the top of the floor guide.

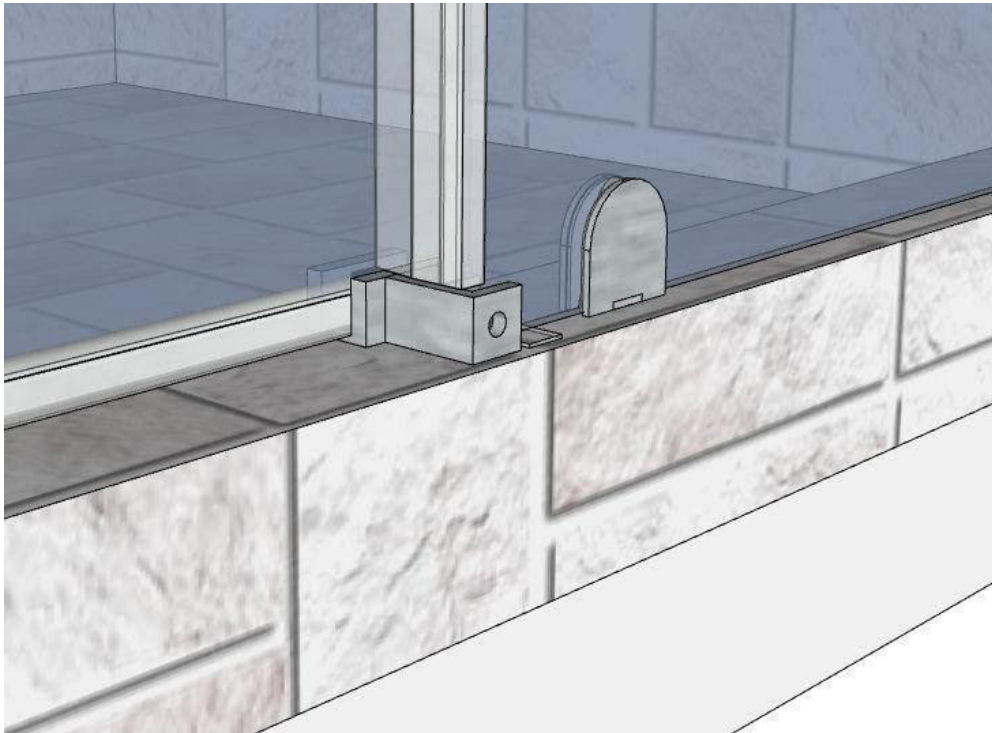

At the top, the PVC should be cut so that it stops ¼” below the anti-lift fitting of the sliding door.

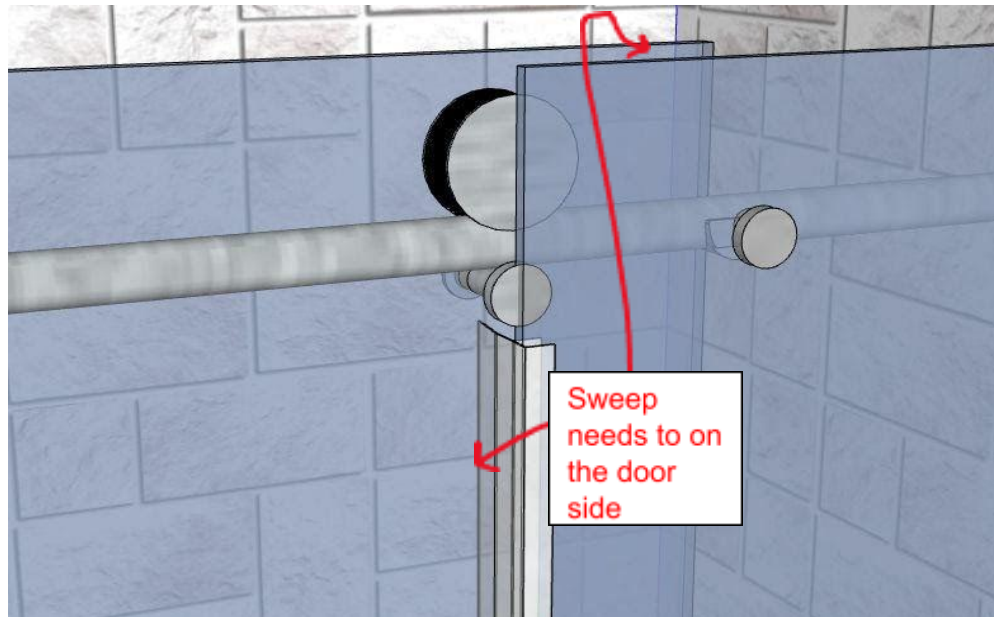

4. Attach the half-moon threshold along the shower/tub base, on the sliding door side. Cut the threshold to meet the wall on one side and the floor guide on the other. Hold the threshold in place temporarily with painter's tape.

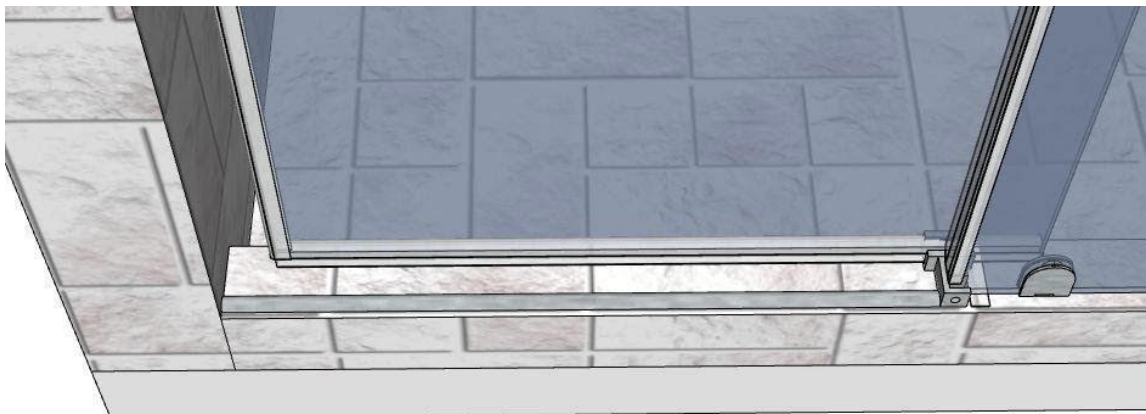

1. The final step is to apply a silicone seal in the following locations:
 - Fixed panel: along the wall side and base sides, both inside and outside the shower. Ensure that all gaps between glass and shower/tub are filled with silicone.
 - Threshold: along both inside and outside edges.
 - Bottom sweep below sliding door: along the top inside edge where the seal meets

METRO SHOW DOOR:
INSTALLATION INSTRUCTIONS



the glass

METRO SHOW DOOR:
INSTALLATION INSTRUCTIONS

